

F1

Field Recorder

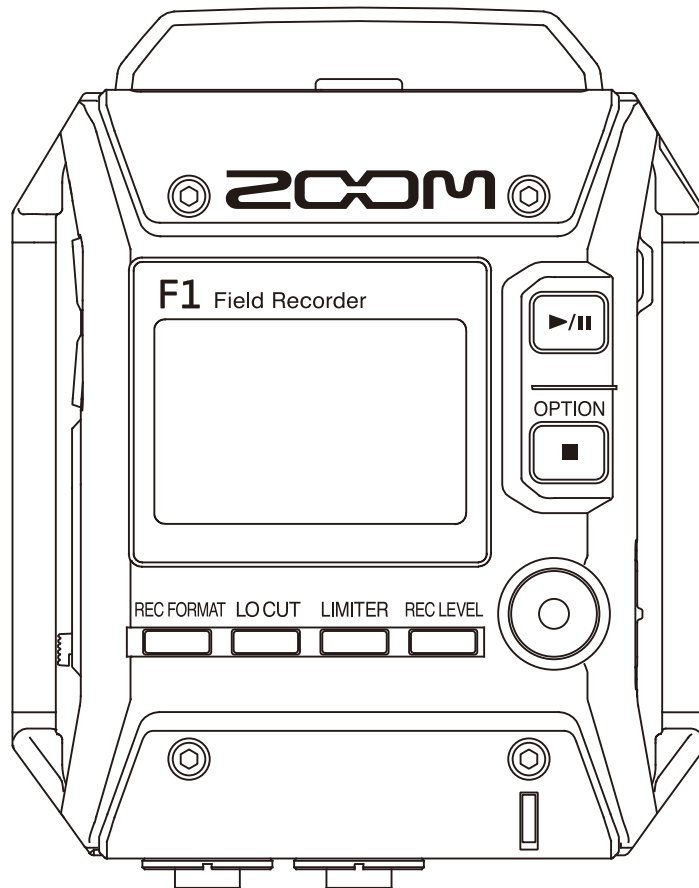

Operation Manual

You must read the Usage and Safety Precautions before use.

© 2018 ZOOM CORPORATION

Copying or reprinting this manual in part or in whole without permission is prohibited.

Usage and Safety Precautions

In this operation manual, symbols are used to highlight warnings and cautions that you must read to prevent accidents. The meanings of these symbols are as follows.



 WARNING Something that could cause serious injury or death	 CAUTION Something that could cause injury or damage to the equipment
--	---

Other symbols used



 An action that is mandatory	 An action that is prohibited
--	--

WARNING

■ **Operation using an AC adapter**

-  Never use any AC adapter other than a ZOOM AD-17.
-  Do not do anything that could exceed the ratings of outlets and other electrical wiring equipment.
Before using the equipment in a foreign country or other region where the electrical voltage differs, always consult with a shop that carries ZOOM products and use the appropriate AC adapter.

■ **Operation with batteries**



-  Use 2 commercially-available AAA batteries (alkaline dry cell batteries, NiMH batteries or lithium dry cell batteries).
-  Carefully study the warning indications of the batteries before use.
-  Always keep the battery cover closed during use.

■ **Alterations**



-  Do not open the case or modify the product.

CAUTION



■ **Product handling**

-  Do not drop, bump or apply excessive force to the unit.
-  Be careful not to allow foreign objects or liquids to enter the unit.





■ **AC adapter handling**

-  When disconnecting the power plug from an outlet, always pull on the plug itself.
-  Disconnect the power plug from the outlet when the unit will not be used for a long time and whenever there is lightning.

■ **Battery handling**

-  Install batteries with the correct +/- orientations.
-  Use the specified batteries.
Do not use new and old batteries together. Do not use batteries of different brands or types together.
-  Remove the batteries when the unit will not be used for a long time.
If a leak occurs, thoroughly wipe the battery case and battery terminals to remove the leaked fluid.

■ **Operating environment**

-  Do not use in extremely high or low temperatures.
-  Do not use near heaters, stoves and other heat sources.
-  Do not use in very high humidity or where it could be splashed by water.
-  Do not use in places with frequent vibrations.
-  Do not use in places with much dust or sand.

■ **Volume**

-  Do not use at a loud volume for a long time.

■ Interference with other electrical equipment

In consideration of safety, the **F1** has been designed to minimize its emission of electromagnetic waves and to suppress interference from external electromagnetic waves. However, equipment that is very susceptible to interference or that emits powerful electromagnetic waves could result in interference if placed nearby. If this occurs, place the **F1** and the other device farther apart.

With any type of electronic device that uses digital control, including the **F1**, electromagnetic interference could cause malfunction, corrupt or destroy data and result in other unexpected trouble. Always use caution.

■ Cleaning

Use a soft cloth to clean the exterior of the unit if it becomes dirty. If necessary, use a damp cloth that has been wrung out well to wipe it.

Never use abrasive cleansers, wax or solvents such as alcohol, benzene or paint thinner.

■ Breakdown and malfunction

If the unit breaks or malfunctions, immediately turn the power off, disconnect the AC adapter, remove the batteries and disconnect other cables. Contact the store where you bought the unit or ZOOM service with the following information: product model, serial number and specific symptoms of breakdown or malfunction, along with your name, address and telephone number.

■ Copyrights

- Windows® is a trademark or registered trademark of Microsoft® Corporation.
- Mac OS is a trademark or registered trademark of Apple Inc.
- The microSD and microSDHC logos are trademarks.
- Other product names, registered trademarks and company names in this document are the property of their respective companies.

Note: All trademarks and registered trademarks in this document are for identification purposes only and are not intended to infringe on the copyrights of their respective owners.

Recording from copyrighted sources, including CDs, records, tapes, live performances, video works and broadcasts, without permission of the copyright holder for any purpose other than personal use is prohibited by law.

Zoom Corporation will not assume any responsibility related to infringements of copyrights.

FCC regulation warning (for U.S.A.)

This equipment has been tested and found to comply with the limits for a Class B digital device, pursuant to Part 15 of the FCC Rules. These limits are designed to provide reasonable protection against harmful interference in a residential installation. This equipment generates, uses, and can radiate radio frequency energy and, if not installed and used in accordance with the instructions, may cause harmful interference to radio communications. However, there is no guarantee that interference will not occur in a particular installation. If this equipment does cause harmful interference to radio or television reception, which can be determined by turning the equipment off and on, the user is encouraged to try to correct the interference by one or more of the following measures:

- Reorient or relocate the receiving antenna.
- Increase the separation between the equipment and receiver.
- Connect the equipment into an outlet on a circuit different from that to which the receiver is connected.
- Consult the dealer or an experienced radio/TV technician for help.

For EU Countries



Declaration of conformity

Introduction

Thank you for purchasing a ZOOM F1 Field Recorder (hereafter, "F1").

The F1 has the following features.

Wearable and compact

Thanks to its compact design, the F1 can be easily attached to clothing during recording sessions.

In addition, the dedicated removable shock mount can be used to reduce noise when mounted on a digital SLR camera.

Compatible with ZOOM mic capsules

The F1 is compatible with all Zoom mic capsules, allowing you to switch microphones according to your audio needs.

Supports various recording formats

Use 96 kHz/24-bit Mono/Stereo PCM (WAV/BWF), MP3 and other formats when recording.

Marks can also be added to and removed from WAV and MP3 files.

Supports multiple languages

In addition to Japanese and English, the F1 allows loading of dedicated files to support various languages.

Compatible with microSDHC cards

The F1 can use microSDHC cards with capacities up to 32 GB. Moreover, the F1 can also be used as a card reader when connected to a computer via USB.

Utilizes an asynchronous transfer system

The F1 utilizes an asynchronous transfer system that is not affected by computer jitter, enabling faithful reproduction of the original sound.

Convenient test tone function

When connecting the F1 to a camera, you can adjust the audio levels for optimal recording.

Useful operation features

Other functions include prerecording of up to two seconds, sound markers convenient for aligning video and audio files, a low-frequency cut filter, a limiter and plug-in power support.

Contents

Usage and Safety Precautions

Introduction

Names of parts

Display overview

Preparations

Providing power

Inserting microSD cards

Turning the power on/off

Setting the language shown

Setting the date and time

Preventing misoperation

Connections

Attaching to a camera

Connecting mics

Setting plugin power

Adjusting the side mic level of a mid-side capsule

Adjusting connected equipment levels (playing test tones)

Recording

Adjusting input levels

Monitoring recording

Reducing noise

Setting the limiter

Selecting the recording format

Recording

Capturing audio before recording starts (PRE REC)

Playback

Playing recordings

Setting the playback mode

Deleting marks

Working with files

Checking file information

Deleting files

Using USB functions

Connecting to computers and iOS devices

Using as a card reader

Using as an audio interface

Making various settings

Setting the recording file name format

Set the recording file type

Automatically disable buttons during recording

Outputting tone signals when starting and stopping recording (sound marker function)

Setting how the counter appears

Setting when marks are added when recording/playing

Setting the display backlight

Adjusting the display contrast

Setting the type of battery used

Setting the time until the power turns off automatically

Other functions

Formatting microSD cards

Testing microSD card performance

Checking the firmware versions

Restoring default setting values

Updating the firmware

Troubleshooting

Specifications

Names of parts

■ Front

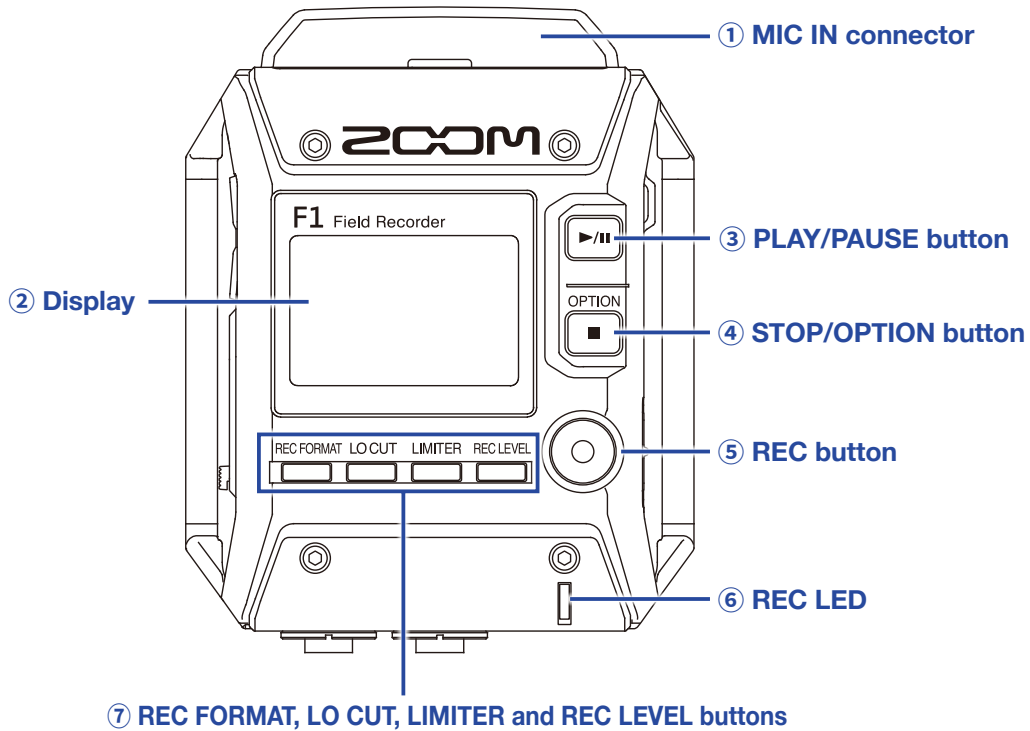

① MIC IN connector

Connect a ZOOM mic capsule here.

② Display

This shows various types of information.

③ PLAY/PAUSE button

Use this to start and pause playback of recorded files.

④ STOP/OPTION button

Use this to stop file recording/playback and to switch the functions of the function buttons.

⑤ REC button

Use this to start recording.

⑥ REC LED

This lights during recording. It blinks when the input sound level is high.

⑦ REC FORMAT, LO CUT, LIMITER and REC LEVEL buttons

Use these to operate the function buttons shown at the bottom of the display.

■ Left and right sides

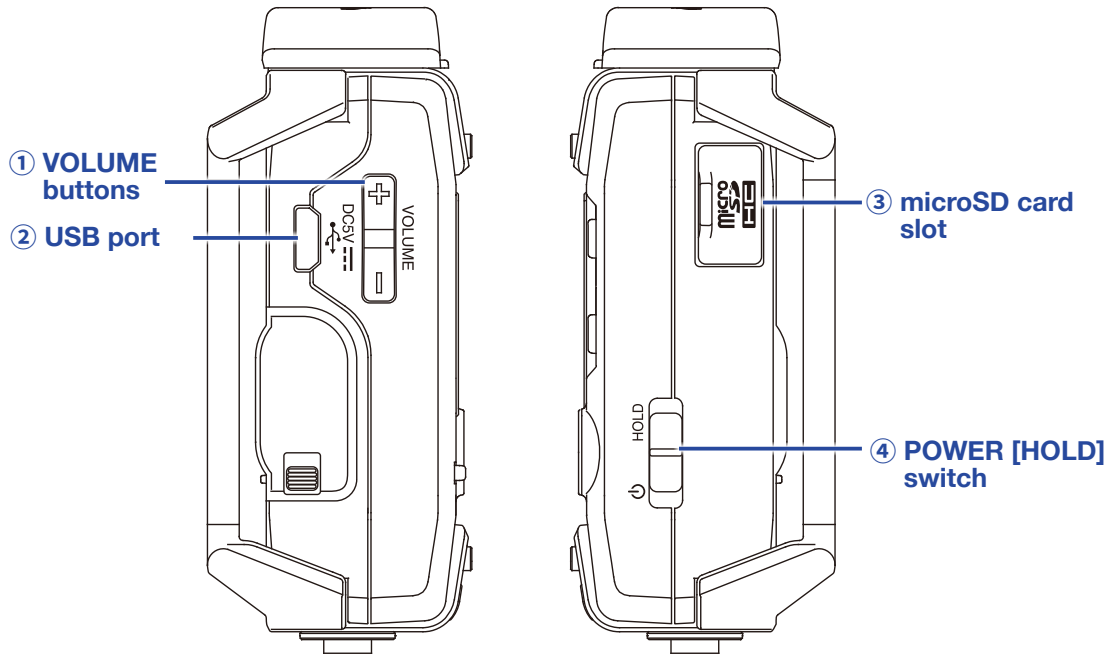

① VOLUME buttons

Use these to adjust the headphone output volume.

② USB port

Connect this to a computer or iOS device to use the **F1** as an audio interface or card reader.

③ microSD card slot

Insert a microSD card here.

④ POWER [HOLD] switch

Use this to turn the power ON/OFF and to disable button operation.

■ Bottom

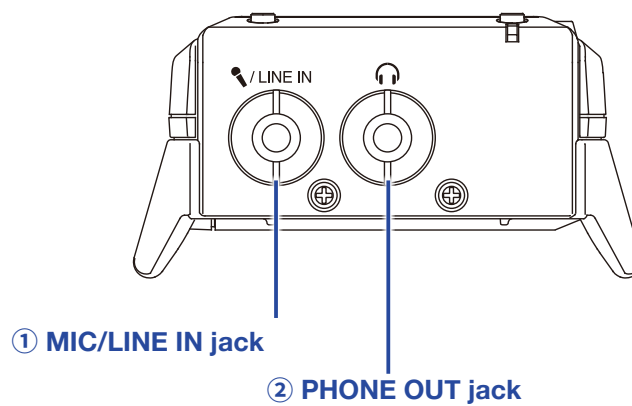

① MIC/LINE IN jack

Connect an external mic here. Mics that require plug-in power can be used with this jack.

② PHONE OUT jack

Connect headphones here.

Display overview

Home Screen (in recording standby)

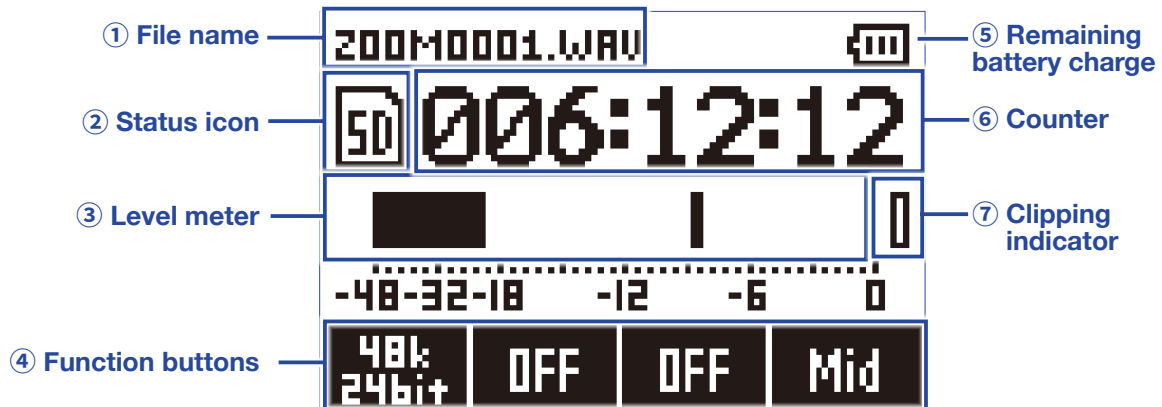

① File name

This shows the name of the recording file.

② Status icon

This shows the recording status.

Ready Recording Paused

③ Level meter

This shows the current input level. The number of level meters displayed changes according to the type of recording file and mic capsule.

④ Function buttons

These display functions that can be set on the Home Screen. From left to right, these correspond to REC FORMAT, LOCUT, LIMITER and REC LEVEL.

⑤ Remaining battery charge

This shows the remaining battery charge. When the remaining battery charge becomes low, replace the batteries (→ ["Using batteries"](#)) or connect an AC adapter (→ ["Using an AC adapter"](#)).

⑥ Counter

This shows the remaining recording time when standing by and the current elapsed recording time when recording or in recording standby (→ ["Setting how the counter is displayed"](#)).

⑦ Clipping indicator

This lights when the input level exceeds the threshold of overload. If the clipping indicator lights, turn down the input level or set the limiter. (→ ["Adjusting input levels"](#)) or set the limiter (→ ["Setting the limiter"](#)).

HINT

Press when the Home Screen is open to switch the functions of the function buttons.

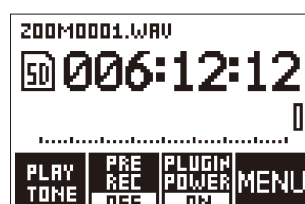

Playback Screen

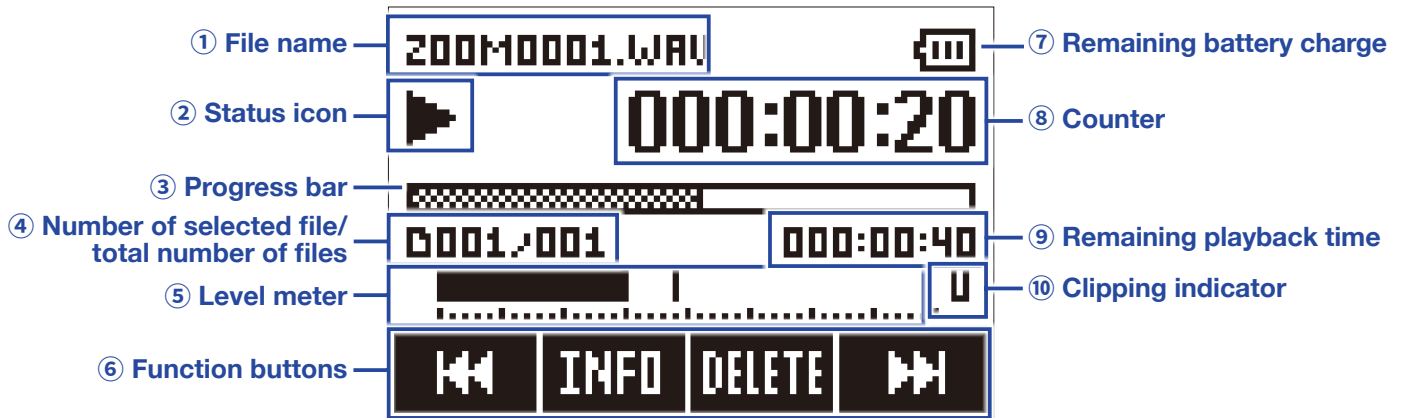

① File name

This shows the name of the file being played.

② Status icon

This shows the playback status.

▶ Playing || Paused ◀ Searching backward ▶ Searching forward

③ Progress bar

This shows the current playback location.

④ Number of selected file/total number of files

⑤ Level meter

This shows the audio playback level.

⑥ Function buttons

These display functions that can be set on the Playback Screen.

⑦ Remaining battery charge

This shows the remaining battery charge. When the remaining battery charge becomes low, replace the batteries (→ ["Using batteries"](#)) or connect an AC adapter (→ ["Using an AC adapter"](#)).

⑧ Counter

This shows the elapsed playback time.

⑨ Remaining playback time

⑩ Clipping indicator

This lights when the playback level is too hot.

Preparations

Providing power

Using batteries

1. Turn the power off and then remove the battery cover.

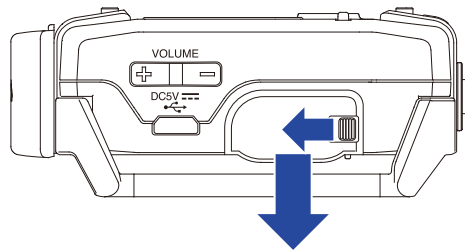

Unlock and pull the cover open

2. Install the batteries.

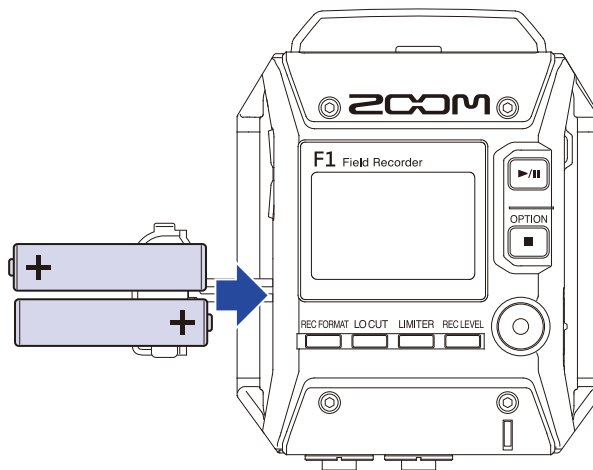

3. Replace the battery cover.

NOTE

- Use only one type of batteries (alkaline, NiMH or lithium) at a time.
- If the remaining battery power indicator drops to 0, turn the power off immediately and install new batteries.
- After installing the batteries, set the battery type correctly (→ "[Setting the type of battery used](#)").

Using an AC adapter

1. Connect the cable of an AD-17 AC adapter to the USB port.

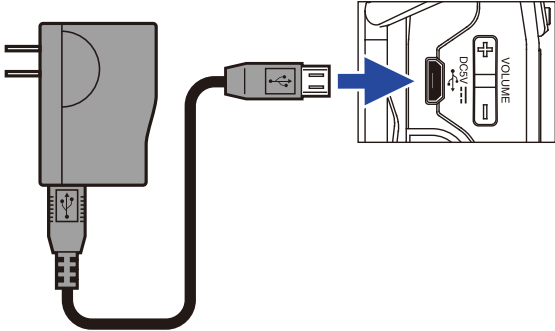

2. Plug the AC adapter into an outlet.

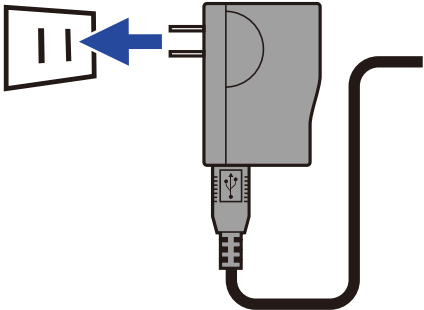

Inserting microSD cards

1. Turn the power off and then open the microSD card slot cover.

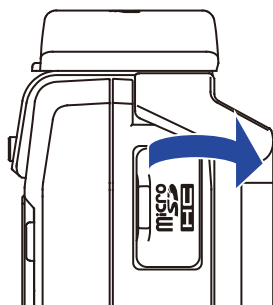

2. Insert the microSD card into the card slot.

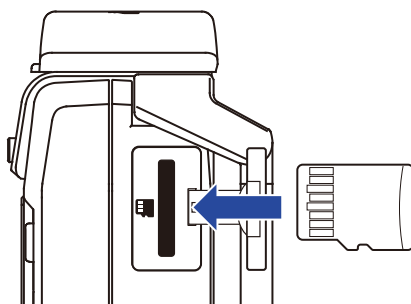

To remove a microSD card, gently push it further into the slot and then pull it out.



3. Close the microSD card slot cover.

NOTE

- Always make certain that the power is off when inserting or removing a microSD card. Inserting or removing a card while the power is on could result in data loss.
- When inserting a microSD card, be sure to insert the correct end with the top side up as shown.
- Recording and playback are not possible when a microSD card is not loaded in the **F1**.
- To format a microSD card, see "[Formatting microSD cards](#)".

Turning the power on/off

Turning the power on

1. Slide  toward  until the Home Screen appears on the display.

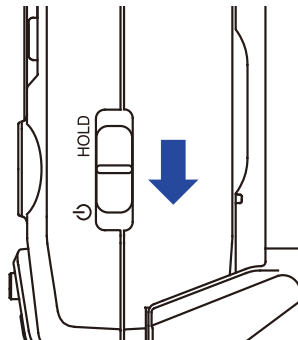

NOTE

- The first time you turn the power on after purchase, you must set the language (→ "[Setting the language shown](#)") and the date/time (→ "[Setting the date and time](#)").
- If "No SD Card!" appears on the display, confirm that a microSD card is inserted properly.
- If "Invalid SD Card!" appears on the display, the card is not formatted correctly. Format the microSD card (→ "[Formatting microSD cards](#)") or use a different microSD card (→ "[Inserting microSD cards](#)").

Turning the power off

1. Slide  toward .

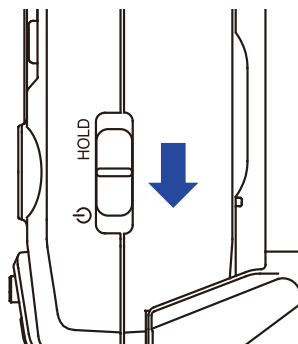





NOTE

Keep sliding the switch until "Power off" appears on the display.



Setting the language shown

Setting the language

Set the language shown on the display.

1. While pressing , press  to open the MENU screen.
2. Use  and  to select "Language", and press .



3. Press  or  to select the language, and press .



HINT

The first time you turn the power on after purchase, this screen opens automatically.

Adding languages

In addition to Japanese and English, various display languages can be added.

1. Copy the file for the language you want to add to the root directory on a microSD card.

HINT

Download language files from the ZOOM website (www.zoom.co.jp).

2. Insert the microSD card into the F1 (→ "[Inserting microSD cards](#)")

3. While pressing , press to open the MENU screen.

4. Use and to select "Language", and press .



5. Use and to select "Add Language", and press .

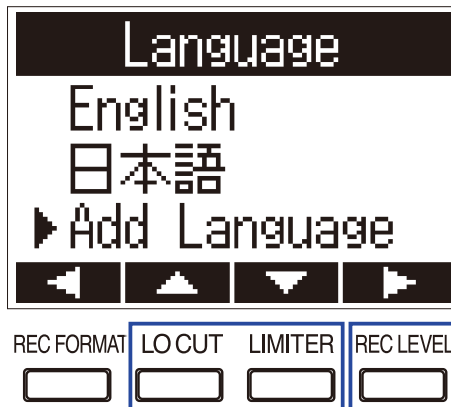

6. Use and to select the language you want to add, and press .

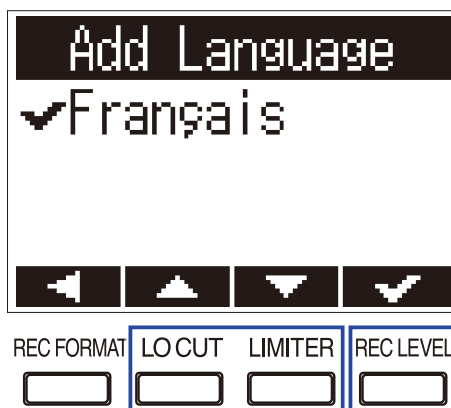





NOTE

- Only one other language can be added at a time. If a different language is added when another language has already been added, the previous language will be deleted.
- Added languages will be deleted if the **F1** is reset (→ ["Restoring default setting values"](#)).

Setting the date and time

Setting the date and time

Set the date and time used when recording files.

1. While pressing , press  to open the MENU screen.
2. Use  and  to select "Date/Time", and press .

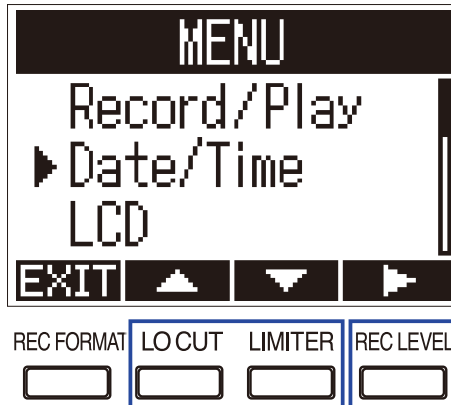

3. Use  or  to select "Set Date/Time", and press .

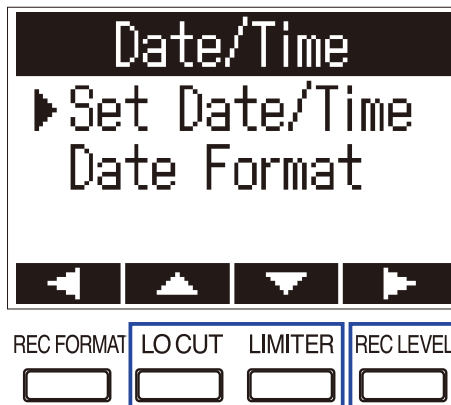

4. Use  and  to select the item to change.

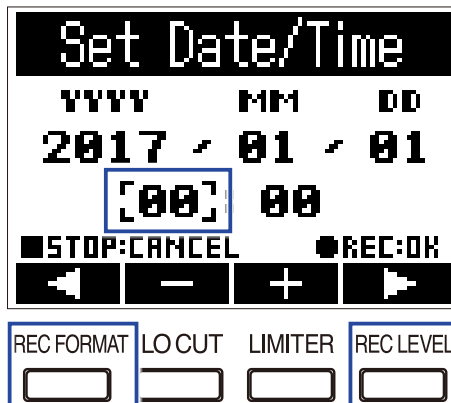

HINT

The first time you turn the power on after purchase, this screen opens automatically after you set the language used.

5. Use and to change the value of the selected item.

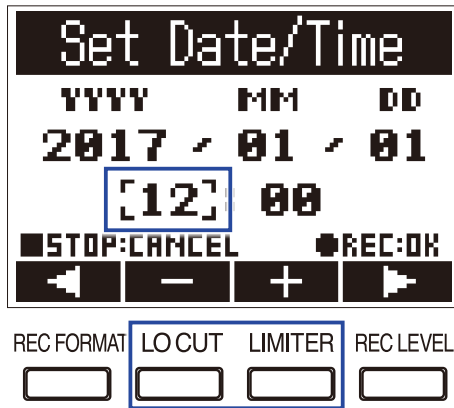

6. Press .

HINT

Press to cancel the setting change.

Setting the date format

The date format can be changed. This is used when adding dates to file names and when showing the date on the Playback Screen.

1. While pressing , press to open the MENU screen.
2. Use and to select "Date/Time", and press .

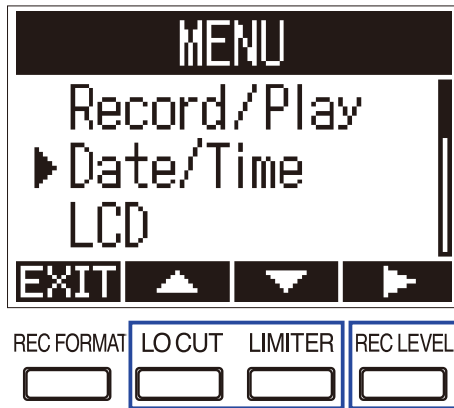

3. Use and to select "Date Format", and press .

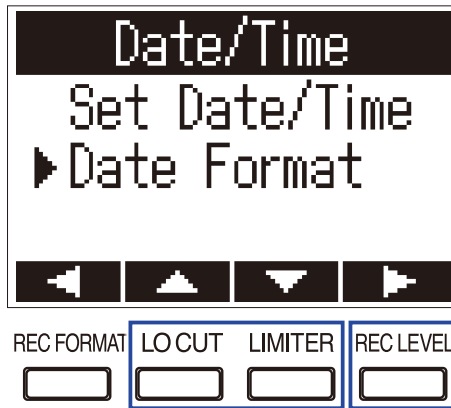

4. Use and to select the date format, and press .

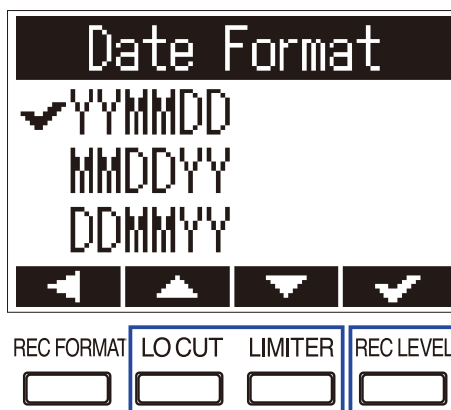

The following date formats can be used.

Setting value	Explanation
YYMMDD	Year, month, day order
MMDDYY	Month, day, year order
DDMMYY	Day, month, year order

Preventing misoperation

In order to prevent misoperation while recording, the hold function can be used to disable the buttons on the F1.

NOTE

This can be set to automatically disable button operation only during recording.
(→ "[Automatically disable buttons during recording](#)")

Activating the HOLD function

1. Slide  to HOLD.

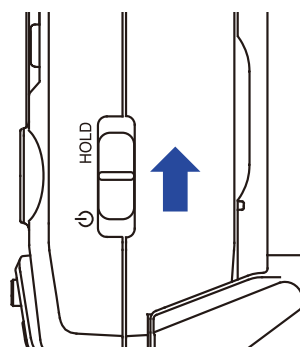

Deactivating the HOLD function

1. Slide  back to the middle.

Connections

Attaching to a camera

Connecting the shock mount

This reduces noise when the F1 is mounted on a digital SLR camera.

1. Attach the ends of two arms from the shock mount to one belt loop on the F1.

2. Attach the other arms to the other belt loop, one at a time.

Using the elasticity of the arms, attach their ends to the belt loops while bending them slightly.

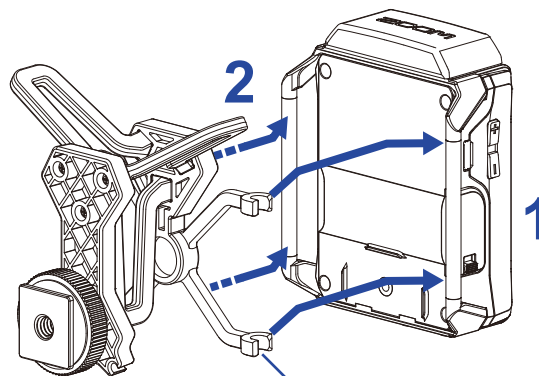

3. Slide the shock mount onto the camera accessory shoe and tighten the screw to attach it.

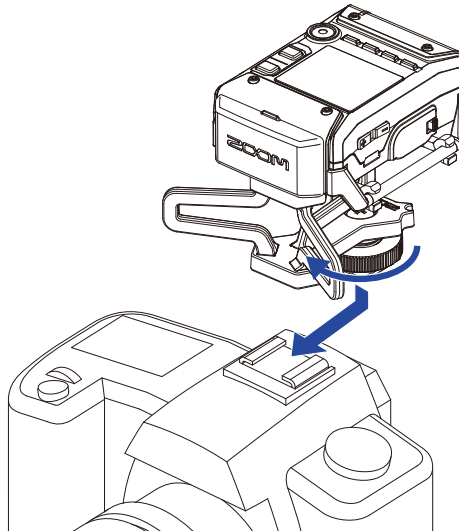

Connecting mics

Connecting mic capsules

1. Remove the protective caps from the **F1** and the mic capsule.

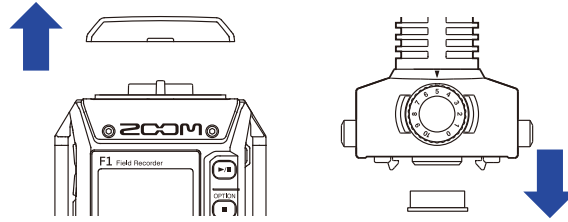

2. While pressing the buttons on the sides of the mic capsule, connect it to the **F1**, inserting it completely.

3. To disconnect the mic capsule, pull it away from the unit while pressing the buttons on its sides.

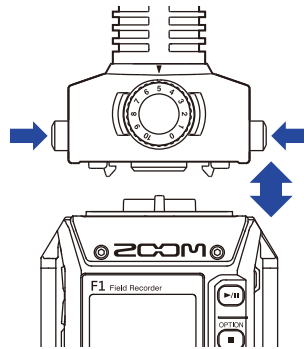

Connecting lavalier mics

1. Attach the windscreen and the clip to the lavalier mic.

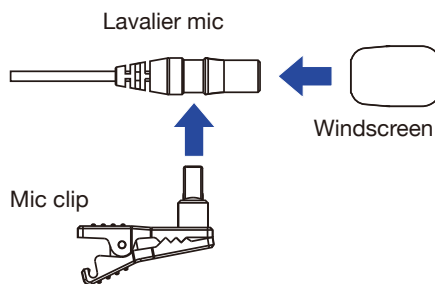

2. Attach the belt clip to the **F1** with the screw.

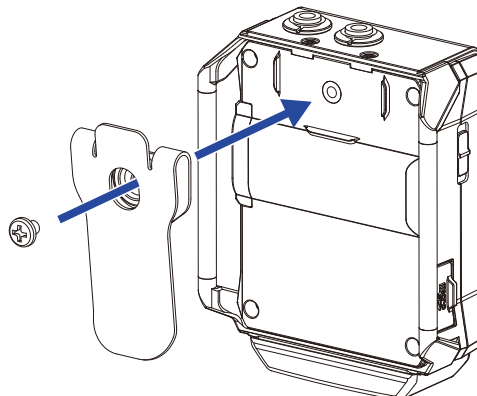

- 3.** Connect the lavalier mic to the MIC/LINE IN jack, and tighten the screw lock.

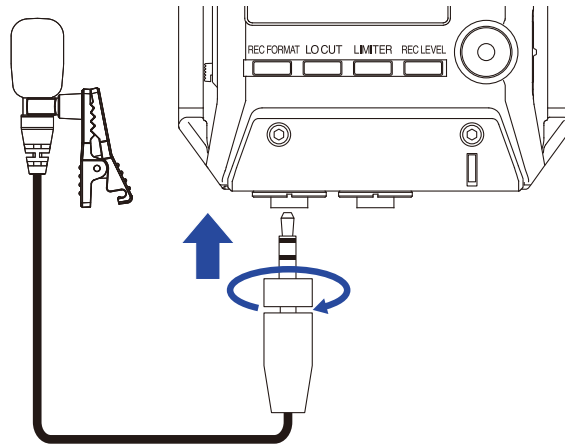

HINT

- This jack can provide plug-in power to mics that use it. (→ "[Setting plugin power](#)")
 - Mics without screw locks can also be connected to the MIC/LINE IN jack.
-

Connection examples

Recording is possible in a variety of situations like these.

■ Recording video while using a lavalier mic

Record sound of performer with lavalier mic connected to the **F1** MIC/LINE IN jack.

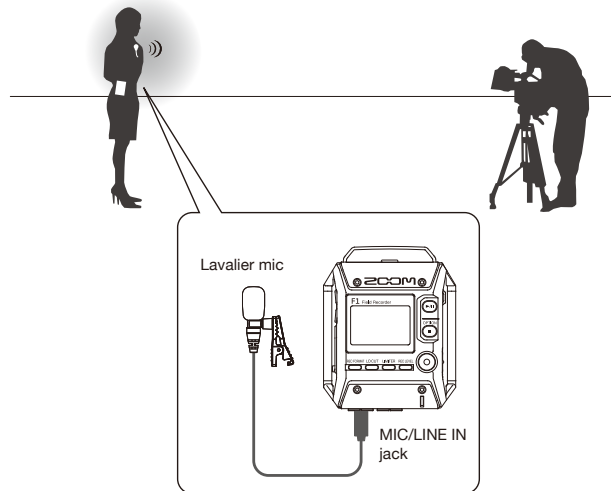

■ Recording video

Record sound of main subject with shotgun mic capsule connected to the **F1**.
Connect the **F1** PHONE OUT jack to the camera mic input.

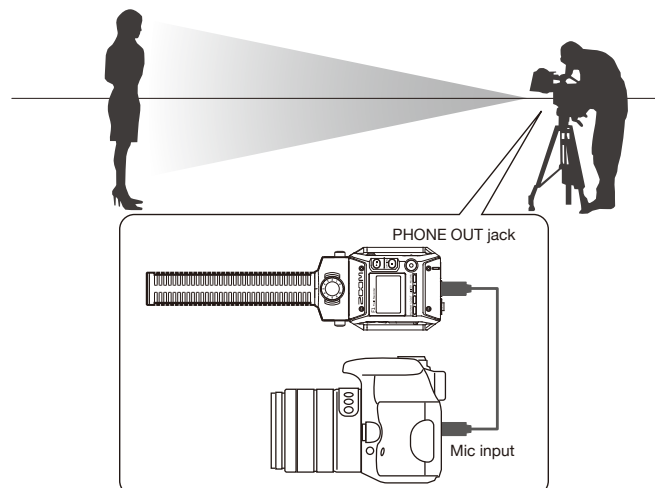

HINT

When connecting the **F1** to the camera, calibrate the levels of both devices by using the built-in test tone.
(→ "[Adjusting connected equipment levels \(playing test tones\)](#)").

Setting plugin power

Use this setting when a mic that is compatible with plug-in power is connected to the **F1** MIC/LINE IN jack or to the MIC/LINE input jack of a mic capsule connected to the **F1**.

1. While pressing , press  to turn it ON.

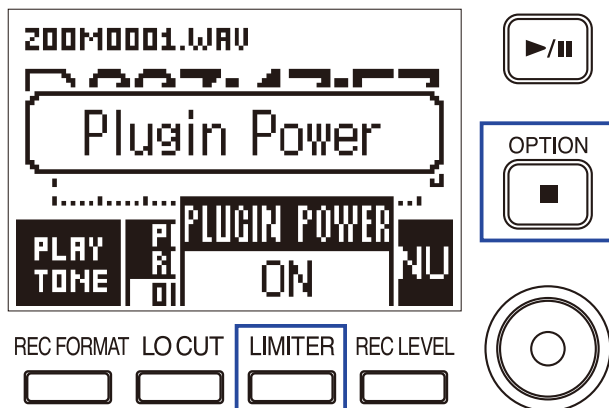

Adjusting the side mic level of a mid-side capsule

You can adjust the side mic level (stereo width) before recording when using a mid-side mic capsule

1. When the mic capsule is connected, press ^{REC LEVEL}, and select the side mic level.

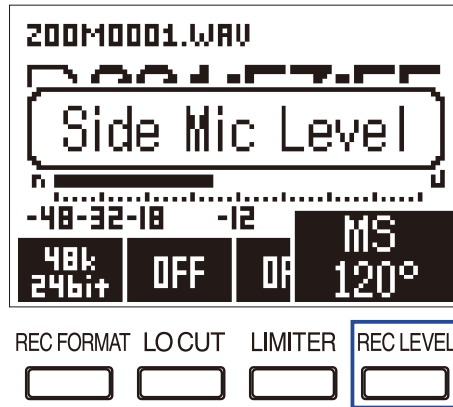

HINT

This can be set to OFF, 30°, 60°, 90°, 120° or 150°.

NOTE

This cannot be changed while recording.

Adjusting connected equipment levels (playing test tones)

Use the test tone in order to adjust the level of a digital SLR camera or other device connected to the F1.

1. Turn down the input gain of the other device.

NOTE

If the automatic gain control function on the other device is on, turn it off.

2. Use an audio cable to connect the external mic jack of the other device with the PHONE OUT jack of the F1.

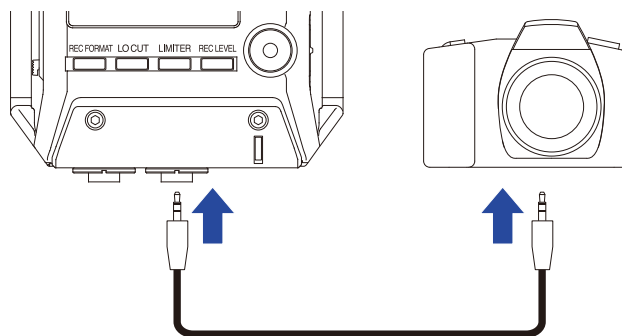

3. While pressing , press .

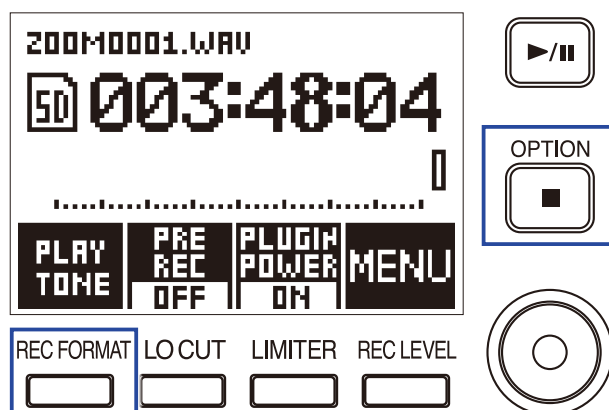

This plays a test tone from the PHONE OUT jack.

NOTE

Be mindful of the volume if you are monitoring the sound with headphones, for example.

HINT

The test tone is a 1kHz sine wave at -6 dBFS.

4. Use  and  to adjust the output level.

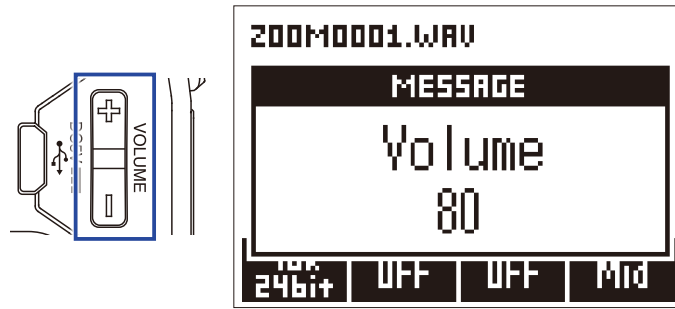

While checking the audio level meter of the other device, adjust the audio signal level so that it never exceeds -6 dB.

5. Adjust the input gain of the other device.

While checking the audio level meter of the connected device, make small adjustments to the input gain of that device until the audio signal level is about -6 dB.

6. While pressing , press .

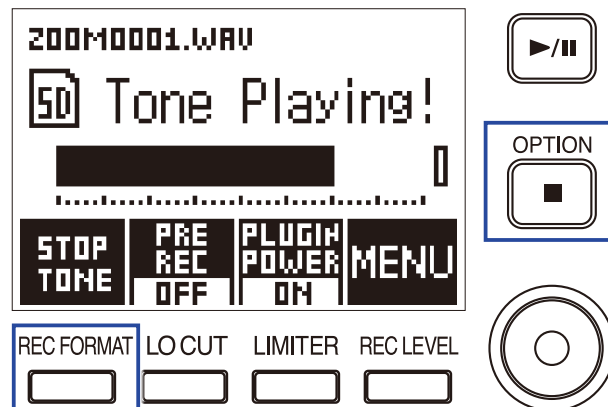

Stop test tone playback.

NOTE

See the operation manual of the other device for information about its operation.

Recording

Adjusting input levels

Adjust the recorded level of signals coming in to the **F1**.

HINT

- Adjust so that the peak level stays around -12 dB.
- Plug-in power can be supplied by the MIC/LINE IN jack as well as by the MIC/LINE IN jack of a connected mic capsule (→ "[Setting plugin power](#)").
- If the sound distorts even when you lower the input level, try changing mic positions and adjusting the output levels of connected devices.
- To cut noise from wind and other sources during recording, see "[Reducing noise](#)".
- To stop input signal clipping, see "[Setting the limiter](#)".

NOTE

Lower the input level if the REC LED flashes.

When using a mic capsule

1. Turn  on the mic capsule to adjust the input level.

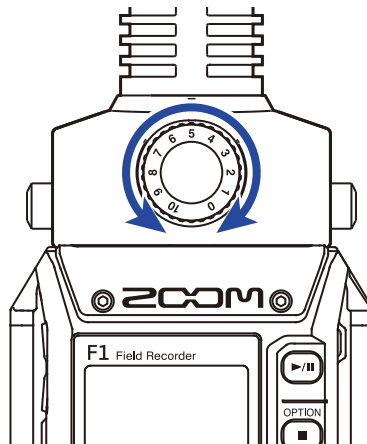

When using the MIC/LINE IN jack

1. Press ^{REC LEVEL}, and select the input level.

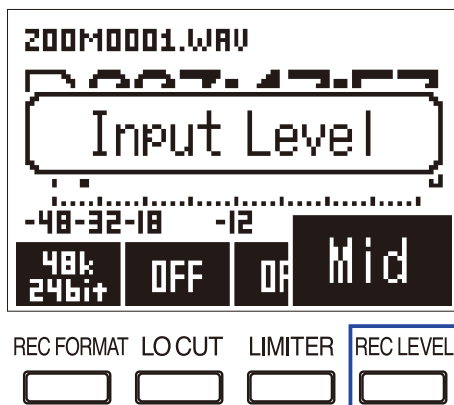

HINT

- This can be set to Lo-, Lo, Mid-, Mid, Mid+, Hi-, Hi, Hi+, Hi++ or AUTO.
 - Select AUTO if you want the input level to be adjusted automatically.
-

Monitoring recording

The sound being recorded can be monitored using headphones.

1. Connect headphones to the PHONE OUT jack on the F1.

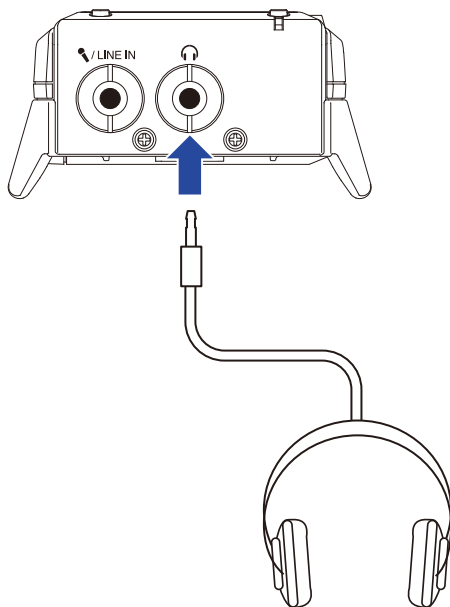

2. Use **+** and **-** to adjust the headphone volume.

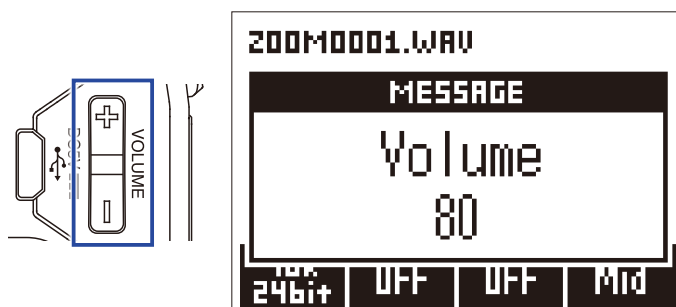

HINT

The volume can be set from 0 to 100.

Reducing noise

This function can reduce low-frequency noise, including wind and vocal pops.

1. Press ^{LO CUT} to set the cutoff frequency.

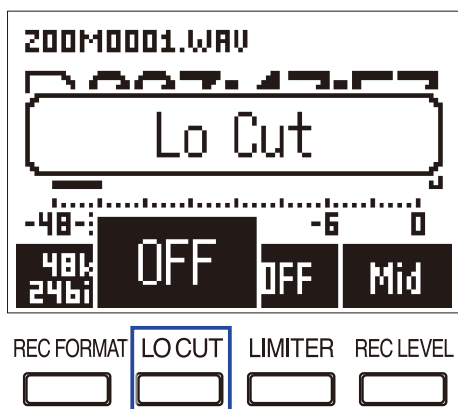

HINT

Select OFF or 80 Hz, 120 Hz or 160 Hz as the frequency.

Setting the limiter

The limiter can prevent distortion by reducing input signals that have excessively high levels.

1. Press ^{LIMITER} to select ON.

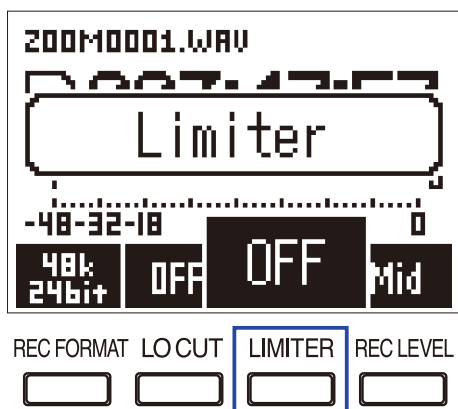

NOTE

When the limiter is ON, noise will be more audible when the input signal level is low.

Selecting the recording format

The recording format can be selected in consideration of audio quality and file size.

1. Press to select the recording format.

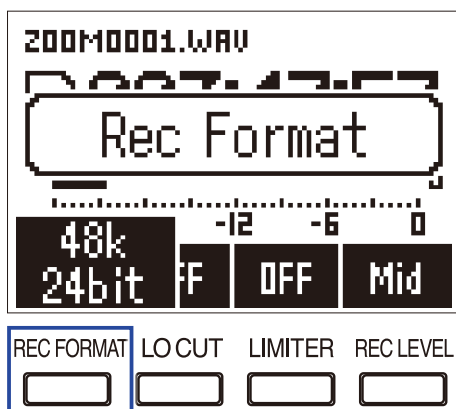

The following recording formats can be set. They are listed in order from highest quality (largest file size) to lowest quality (smallest file size).

- 96k 24bit (96 kHz/24-bit WAV)
- 48k 24bit (48 kHz/24-bit WAV)
- 48k 16bit (48 kHz/16-bit WAV)
- 44.1k 16bit (44.1 kHz/16-bit WAV)
- MP3 320k (320 kbps MP3)
- MP3 256k (256 kbps MP3)
- MP3 192k (192 kbps MP3)
- MP3 128k (128 kbps MP3)
- MP3 48k (48 kbps MP3)

NOTE

This cannot be changed while recording.

HINT

- WAV format is better for recording when audio quality is important.
- When recording in MP3 format, the audio quality is reduced, but the file size is smaller. This is convenient when you want to record large amounts and use less space on the microSD card, for example.

Recording

1. Press  to record.

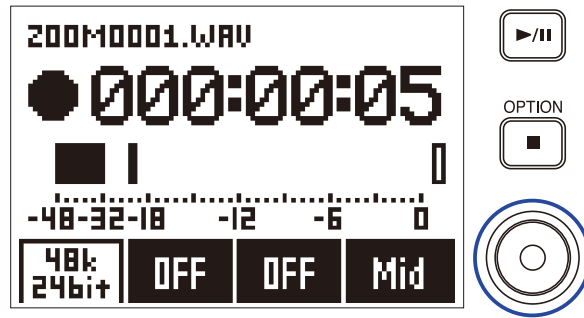



2. Press  to pause/resume.

Pausing during recording will add a mark at that instant.

HINT

How pausing occurs and marks are added when  is pressed can be changed.
(→ ["Setting how marks are added when recording/playing"](#))

NOTE

- Marks are used as cue points. During playback, press  or  to jump to a mark position.
- Up to 99 marks can be added to each recording.
- If the file size exceeds 2 GB during recording, a new file will be created automatically and recording will continue without pause.
- When using a mono shotgun mic capsule, recorded WAV files will be mono.

3. Press  to stop.

NOTE

If the power is interrupted or another problem occurs during recording, an affected file can be restored to normal by playing it with the **F1**.

Capturing audio before recording starts (PRE REC)

The input signal can be captured for about 2 seconds before  is pressed. This is useful when a performance starts suddenly, for example.

1. While pressing , press  to turn on Pre Rec.

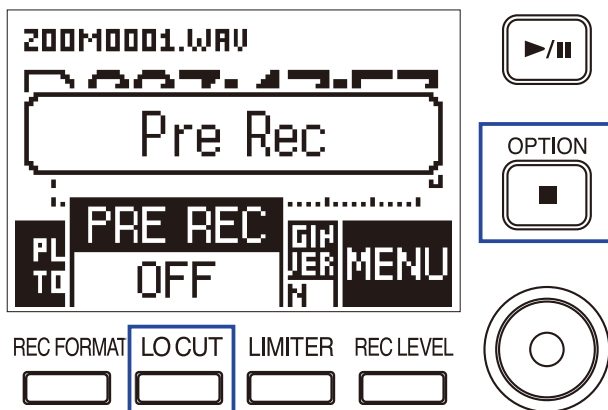

Playback

Playing recordings



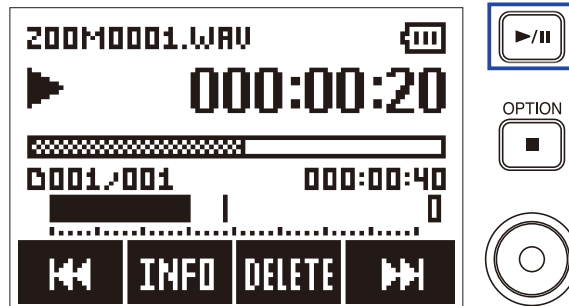

1. Press .



The following operations can be performed during playback.

Adjust the headphone volume	Use  and  .
Pause/resume playback and add a mark (This operation can be changed with a setting.) (→ "Setting how marks are added when recording/playing")	Press  .
Search forward	Press and hold  .
Search backward	Press and hold  .
Jump to the next mark (if one exists) Play the next file (if no mark exists)	Press  .
Jump to the previous mark (if one exists) Jump to the beginning of the file/play the previous file (if no mark exists)	Press  .
Delete a mark (→ "Deleting marks")	Press  when paused at a mark
Delete a file (→ "Deleting files")	Press  .
Display file information (→ "Checking file information")	Press  .

NOTE

- Marks are used as cue points.
- If you press  after the last mark during playback, the next file will be played. If you press  before the first mark during playback, the previous file will be played.
- When searching backward/forward, the longer you press and hold  / , the faster the search speed will become.

2. Press  to stop.

Setting the playback mode

You can set the file playback mode to Play All, Repeat One, or Repeat All.

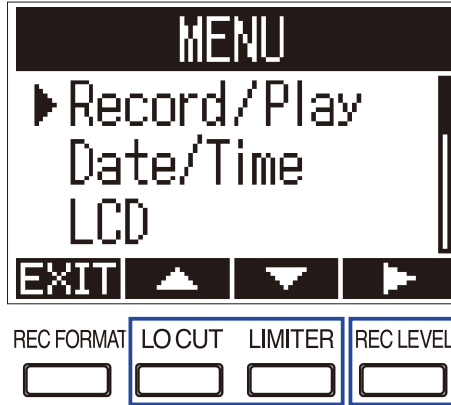

1. While pressing , press  to open the MENU screen.

2. Use  and  to select "Record/Play", and press .

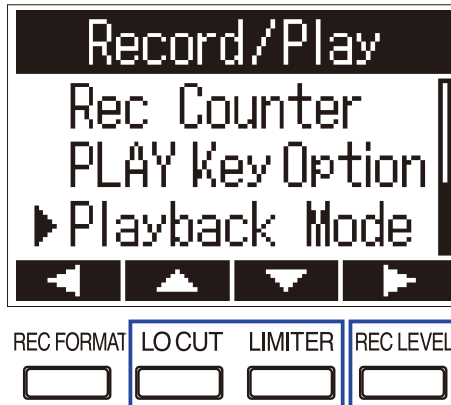

3. Use  and  to select "Playback Mode", and press .



4. Use  and  to select the playback mode, and press .

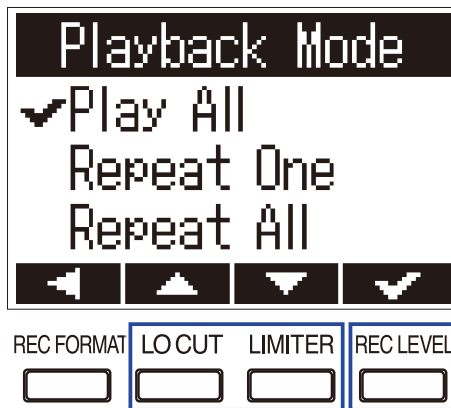

The following playback modes can be set.

Setting value	Explanation
Play All	Every file from the selected one to the last one will be played back.
Repeat One	The one selected file will be played repeatedly.
Repeat All	All files will be played back repeatedly.

Deleting marks

Marks added to files can be deleted when not needed.

1. Pause playback.
2. Use ^{REC FORMAT} and ^{REC LEVEL} to jump to the mark that you want to delete.

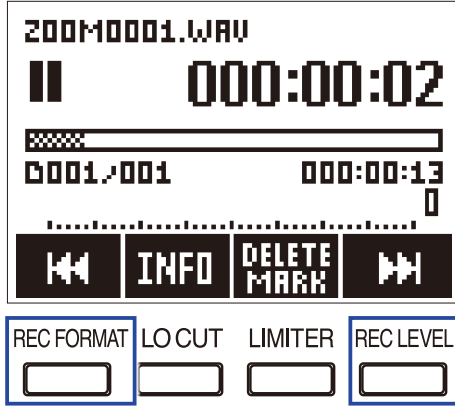

3. Press ^{LIMITER}.
4. Use ^{LO CUT} and ^{LIMITER} to select "Delete", and press ^{REC LEVEL}.



Working with files

Checking file information

You can view a variety of information about the selected file.

1. Press while the file is playing to check its information.

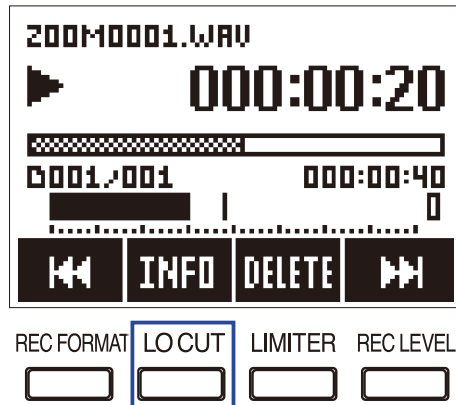

2. Check the file information.

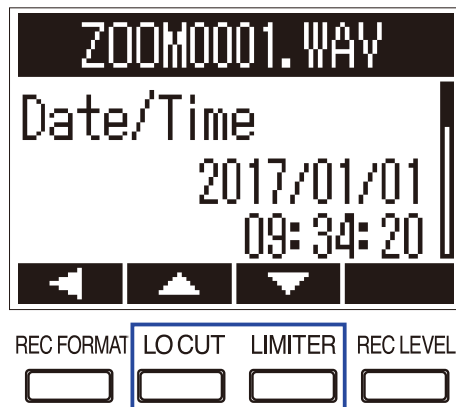

Use and to change the page.

HINT

The information items that can be viewed are the date and time, the format, the size, and the recording length.

Deleting files

You can delete unwanted files.

1. Press ^{LIMITER} during playback of the file to delete.

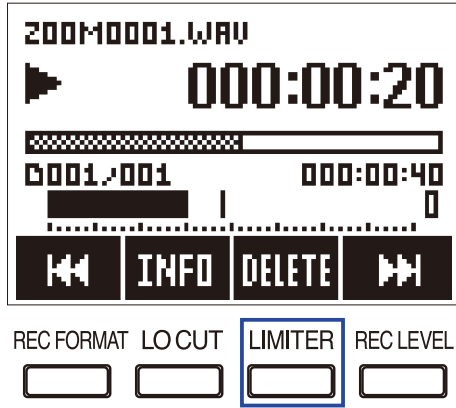

2. Use ^{LO CUT} and ^{LIMITER} to select "Delete", and press ^{REC LEVEL}.

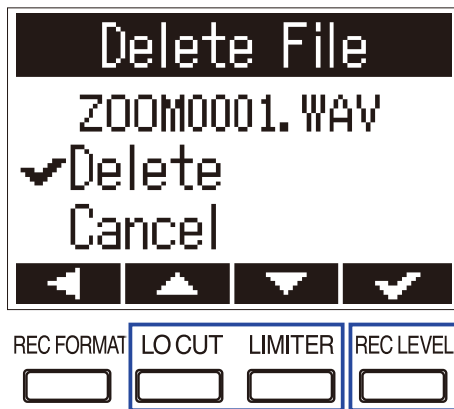

Using USB functions

Connecting to computers and iOS devices

The **F1** can be used as a card reader or audio interface when the **F1** is connected to a computer, iOS device or other equipment.

1. When the Home Screen is open, use a USB cable to connect the **F1** to a computer or iOS device.

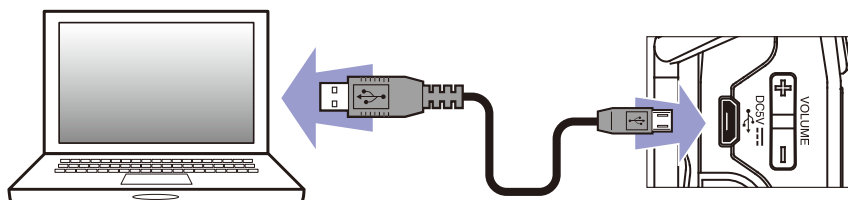

The USB screen will open.

NOTE

A Lightning to USB Camera Adapter is necessary to connect an iOS device.

Using as a card reader

You can use a computer to check the files saved on the microSD card and copy those files to the computer.

1. Press ^{LOCUT} or ^{LIMITER} on the USB screen to select "Card Reader", and press ^{REC LEVEL}.

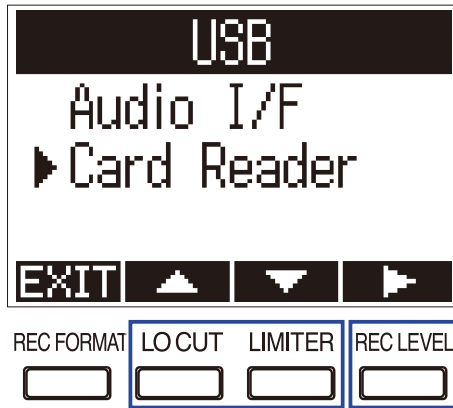

2. Use the computer to transfer the files saved on the microSD card.



3. When you want to disconnect, use the computer to end the USB connection with the **F1**.
Windows: Select **F1** from "Safely Remove Hardware".
Mac OS: Drag the **F1** icon to the Trash and drop it.

NOTE

Always properly eject the **F1** before removing the USB cable.

4. Press ^{REC LEVEL}.
5. Use ^{LOCUT} and ^{LIMITER} to select "Exit", and press ^{REC LEVEL}.

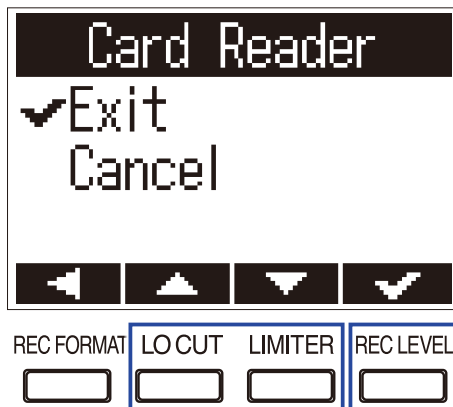

6. Disconnect the USB cable from the **F1** and the computer.

Using as an audio interface

F1 input signals can be input directly to a computer, iOS device or other equipment, and playback signals on a computer, iOS device or other equipment can be output from the F1.

1. Press ^{LOCUT} or ^{LIMITER} on the USB screen to select "Audio I/F", and press ^{REC LEVEL}.

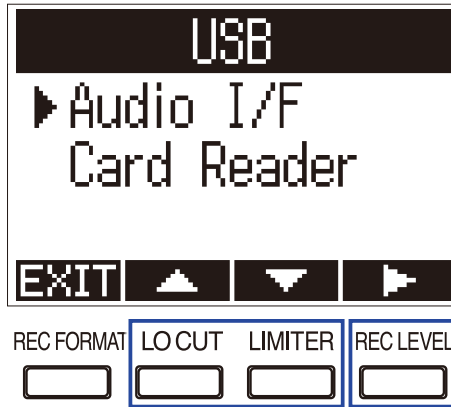

2. Use ^{LOCUT} or ^{LIMITER} to select the type of device, and press ^{REC LEVEL}.

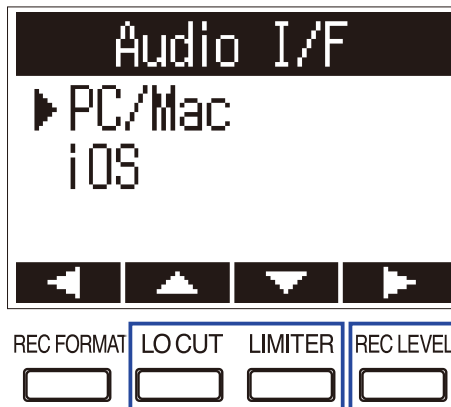

NOTE

After selecting "iOS", turn the F1 power on, follow the instructions on screen, and disconnect the cable once. Then, select "iOS" again and reconnect the cable.

3. After selecting PC/Mac, use ^{LOCUT} or ^{LIMITER} to select the power source, and press ^{REC LEVEL}.

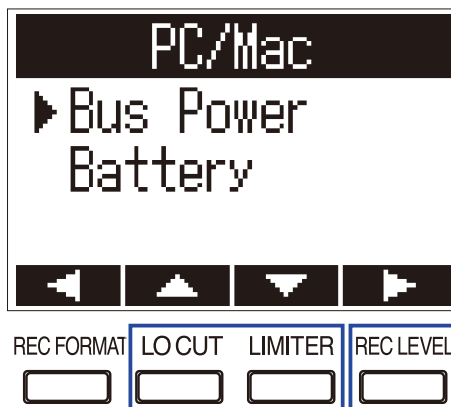

The following power sources can be selected.

Setting value	Explanation
Bus Power	Power is supplied from the computer through the USB cable.
Battery	Power is supplied by the batteries in the F1. Select this when connected to a computer that has low USB bus power supply capability.

NOTE



When "iOS" is selected, power is supplied by the batteries in the F1. This screen will not be shown.

4. Monitor playback signals from the computer or iOS device.





HINT

When connected to a Windows computer, you can use a dedicated driver for low-latency monitoring. Download the driver from the ZOOM website (www.zoom.co.jp).

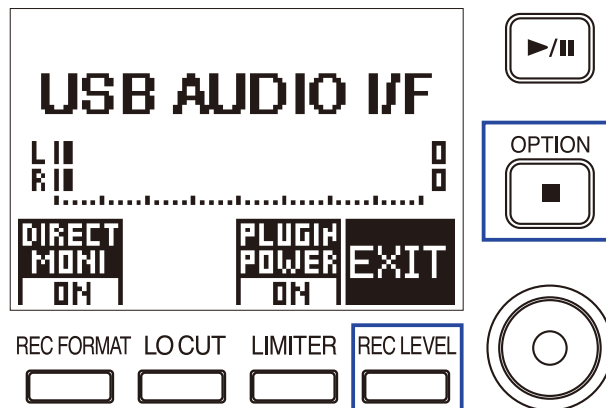
5. To disconnect, while pressing , press .



6. Use  and  to select "Exit", and press .

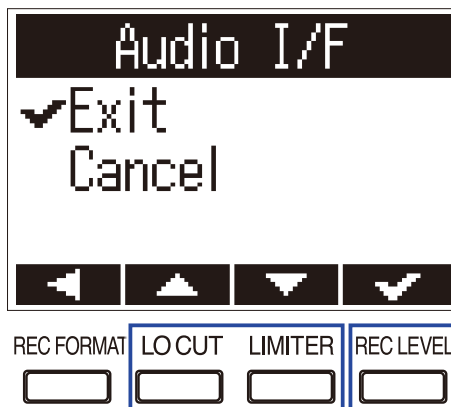

7. Disconnect the USB cable from the F1 and the computer or iOS device.

Enabling direct monitoring

This directly outputs the F1 input signal from the F1 before sending it to the computer or iOS device. This enables monitoring without latency.

1. While pressing , press  to turn on direct monitoring.

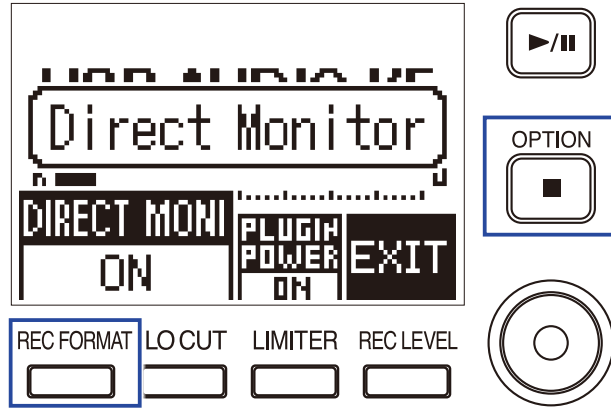

Making various settings

Setting the recording file name format

The format can be set for the names given to files automatically during recording.

1. While pressing , press to open the MENU screen.
2. Use and to select "Record/Play", and press .

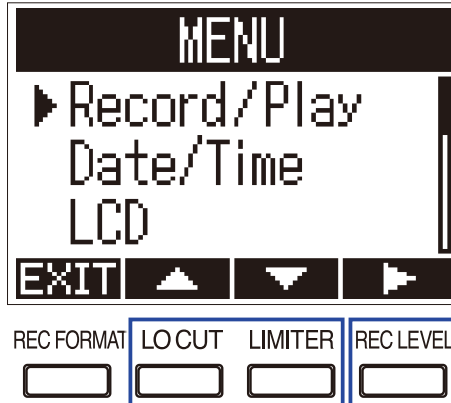

3. Use and to select "Rec File Name", and press .

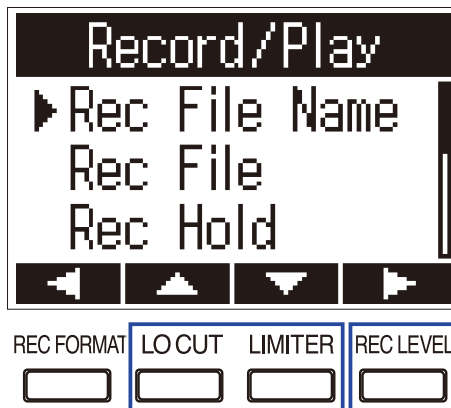

4. Use ^{LOCUT} or ^{LIMITER} to select the file name format, and press ^{REC LEVEL}.

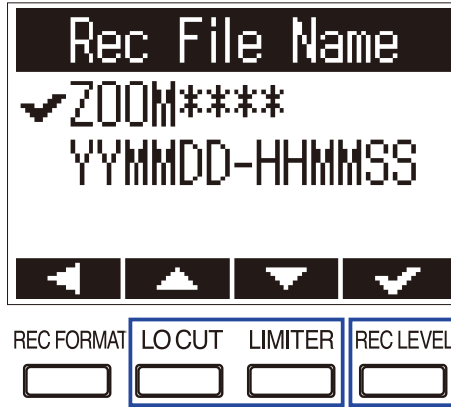

The following file name formats can be used.

Setting value	Explanation
ZOOM****	Files are named with consecutive numbers from "ZOOM0001.WAV/MP3" to "ZOOM9999.WAV/.MP3".
YYMMDD-HHMMSS	Files are named with the date and time that the recording started, using a "YYM-MDD-HHMMSS.WAV/MP3" format. The "Date Format" setting will be used for the date used as the file name (→ "Setting the date format").

Set the recording file type

When using the F1 MIC/LINE IN jack, the recording file type (mono/stereo) can be selected. This cannot be set when using a ZOOM mic capsule.

1. While pressing , press to open the MENU screen.

2. Use and to select "Record/Play", and press .

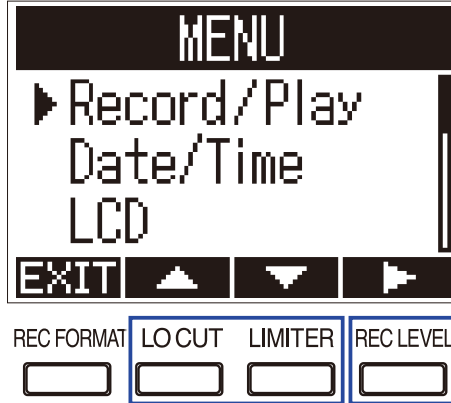

3. Use and to select "Rec File", and press .

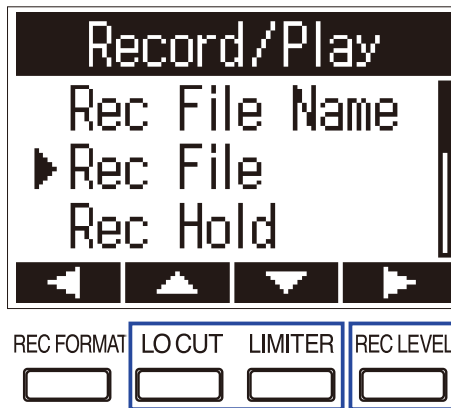

4. Use and to select the file type, and press .

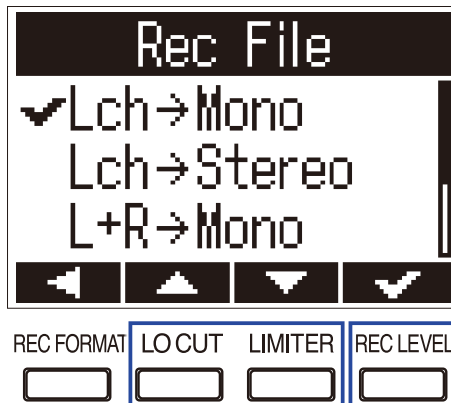



The following file types can be set.

Setting value	Explanation
L ch → Mono	The left channel of the input signal is saved as a mono file.
L ch → Stereo	The left channel of the input signal is saved as a stereo file. The same audio is saved to both the left and right channels of the file.
L+R → Mono	The left and right channels of the input signal are mixed together and saved as a mono file.
L/R → Stereo	The input signal is saved as a stereo file.
L+R → Stereo	The left and right channels of the input signal are mixed together and saved as a stereo file. The same audio is saved to both the left and right channels of the files.

Automatically disable buttons during recording

Button operations can be disabled during recording to prevent misoperation.

To stop recording when this function is on, while pressing , press .

1. While pressing , press  to open the MENU screen.

2. Use  and  to select "Record/Play", and press .

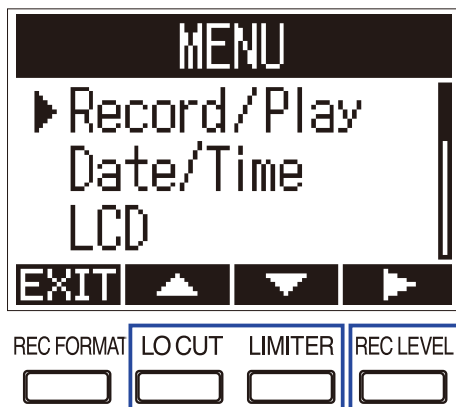

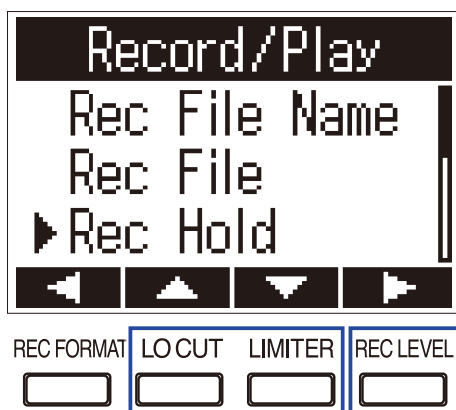

3. Use  and  to select "Rec Hold", and press .

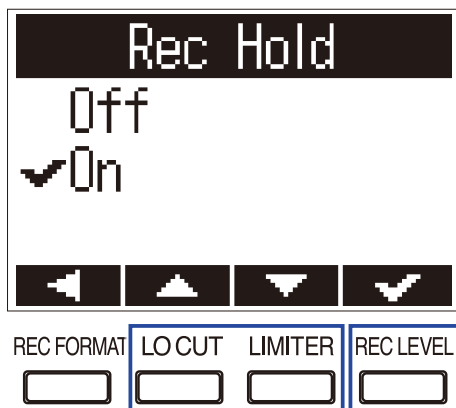

4. Use  or  to select "On", and press .



Setting value	Explanation
Off	Button operations will not be automatically disabled during recording.
On	Button operations will be disabled during recording. To stop recording, while pressing  , press  .

HINT

Even while button operations have been automatically disabled during recording,  and  can be used.



Outputting tone signals when starting and stopping recording (sound marker function)

Half-second tone signals (sound markers) can be played from the PHONE OUT jack when recording starts and stops. Since sound markers are also written to files, when recording audio for video with the **F1**, sending the **F1** output signal to the camera input can make synchronizing audio and video easier.

1. While pressing , press  to open the MENU screen.

2. Use  and  to select "Record/Play", and press .



3. Use  and  to select "Sound Marker", and press .



4. Use  or  to select "On", and press .

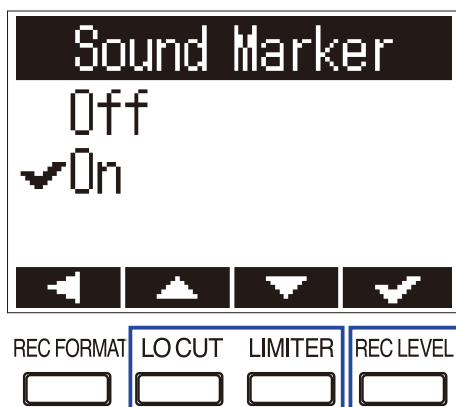

NOTE

Be careful of the volume if you are monitoring the sound with headphones, for example.



Setting how the counter is displayed

The counter shown during recording can be set to either the elapsed recording time or the remaining possible recording time.

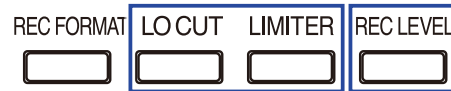

1. While pressing , press  to open the MENU screen.

2. Use  and  to select "Record/Play", and press .

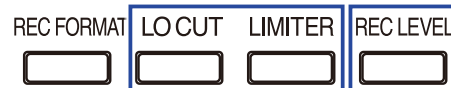

3. Use  and  to select "Rec Counter", and press .



4. Press  or  to select how it is shown, and press .

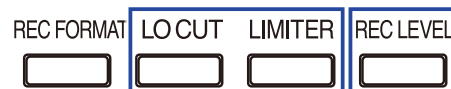

Setting how marks are added when recording/playing

You can set how marks are added when  is pressed while recording and playing back.

1. While pressing , press  to open the MENU screen.

2. Use  and  to select "Record/Play", and press .

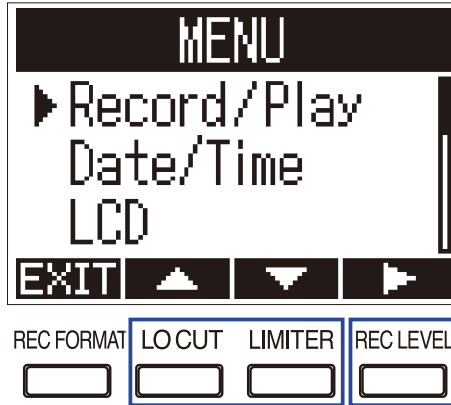

3. Use  or  to select "PLAY Key Option", and press .



4. Use  and  to select "Recording" or "Playing", and press .

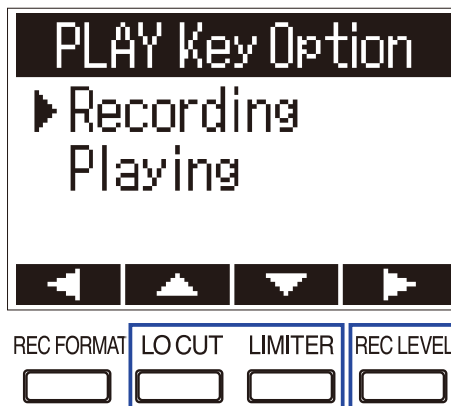

5. Use ^{LOCUT} and ^{LIMITER} to select when marks are added, and press ^{REC LEVEL}.



Setting value	Explanation
Pause	Pressing will pause without adding a mark.
Pause & Mark	Pressing will pause and add a mark.
Mark	Pressing will add a mark without pausing.

Setting the display backlight

You can set the display backlight to turn off after a specific amount of time without use.

1. While pressing , press  to open the MENU screen.

2. Use  and  to select "LCD", and press .

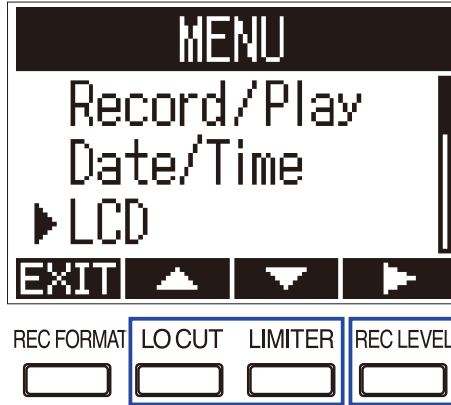

3. Use  and  to select "Backlight", and press .

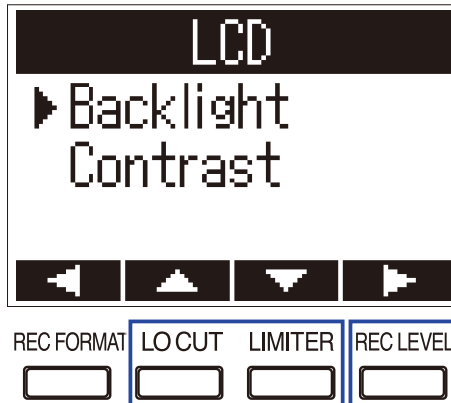

4. Use  and  to set the amount of time until the backlight turns off, and press .

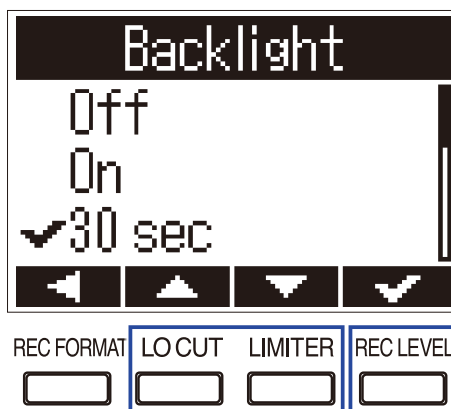

HINT

This can be set to Off, On, 30 seconds, or 1 to 5 minutes.

Adjusting the display contrast

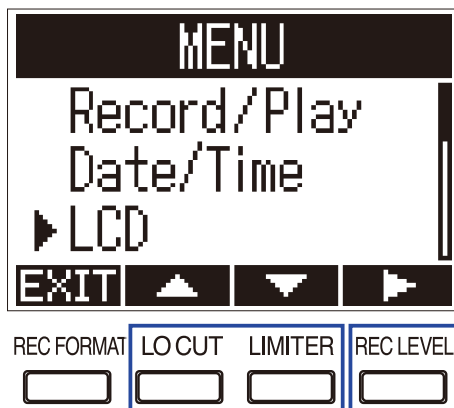

1. While pressing , press  to open the MENU screen.

2. Use  and  to select "LCD", and press .



3. Use  and  to select "Contrast", and press .



4. Use  and  to adjust the contrast, and press .

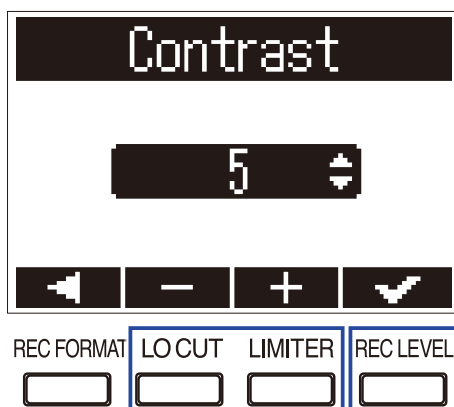

HINT

This can be set from 1 to 10.

Setting the type of battery used

Set the type of battery used so that the amount of remaining battery charge can be accurately displayed.

1. While pressing , press to open the MENU screen.

2. Use or to select "Battery", and press .

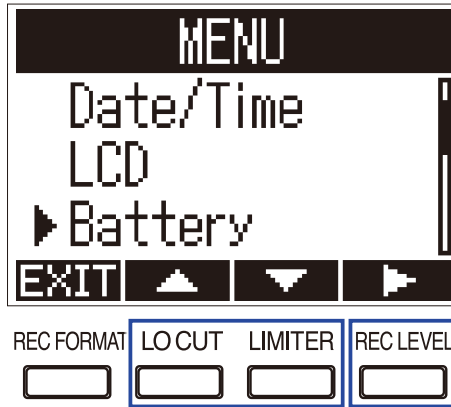

3. Use and to select the battery type, and press .



Setting the time until the power turns off automatically

You can set the **F1** to automatically turn off after being unused for a specific amount of time.

1. While pressing , press to open the MENU screen.
2. Use or to select "Auto Power Off", and press .

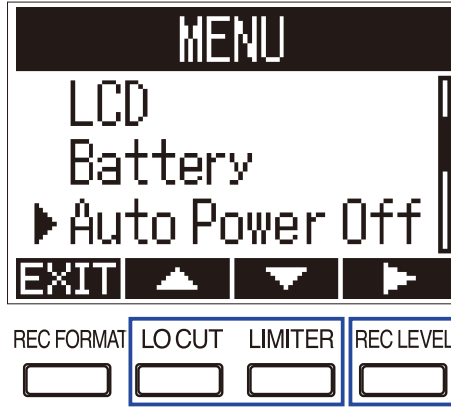

3. Use and to set the time until the power turns off, and press .

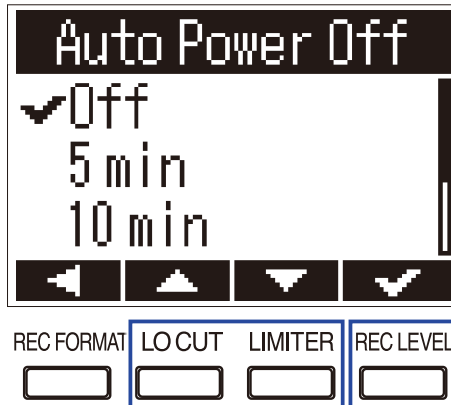

HINT

This can be set to Off, 5, 10, 30, or 60 minutes.

Other functions

Formatting microSD cards

A microSD card that has been purchased or formatted by a computer should be reformatted for use with the F1.

1. While pressing , press to open the MENU screen.
2. Use and to select "SD Card", and press .

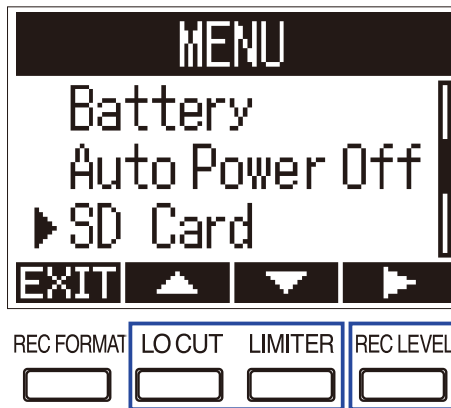

3. Use and to select "Format", and press .

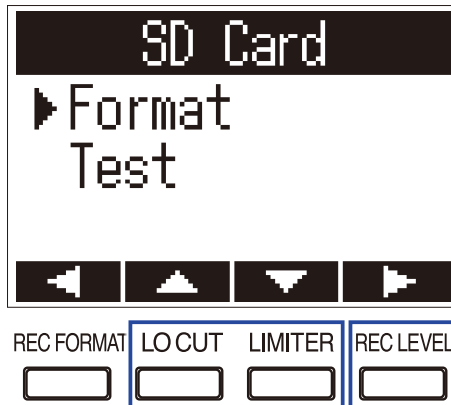

4. Use and to select "Execute", and press .

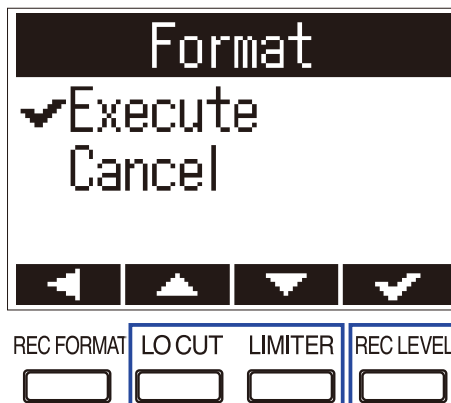

NOTE

- Before using a microSD card, it must be formatted by the **F1**.
- Be aware that all data previously saved on a microSD card will be deleted when it is formatted.

Testing microSD card performance

Use "Quick Test" or "Full Test" to check the current microSD card's compatibility with the F1.

A Quick Test can be done in a short amount of time, while a Full Test takes longer to examine the entire microSD card.

NOTE

Even if a performance test result is "OK", there is no guarantee that writing errors will not occur. Use this information as a guide.

Conducting a Quick Test

1. While pressing , press to open the MENU screen.
2. Use and to select "SD Card", and press .

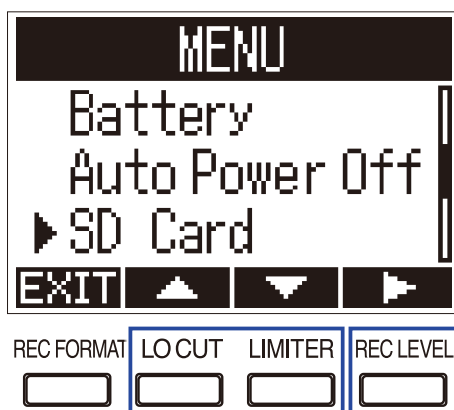

3. Use or to select "Test", and press .

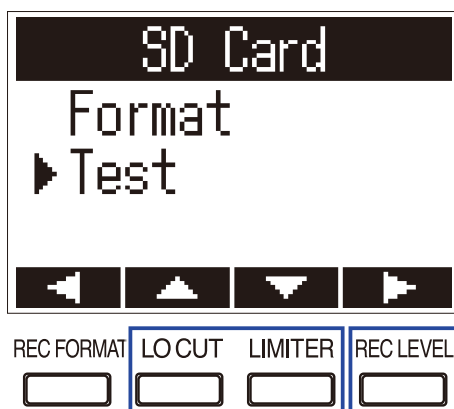

4. Use or to select "Quick Test", and press .

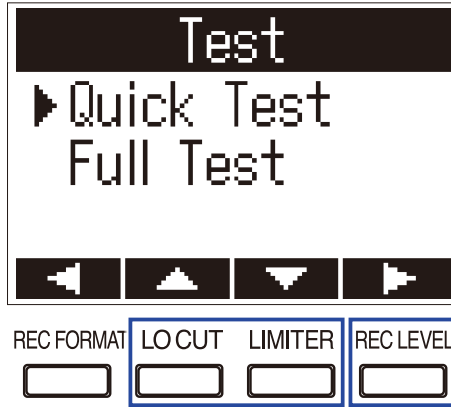

5. Use and to select "Execute", and press .

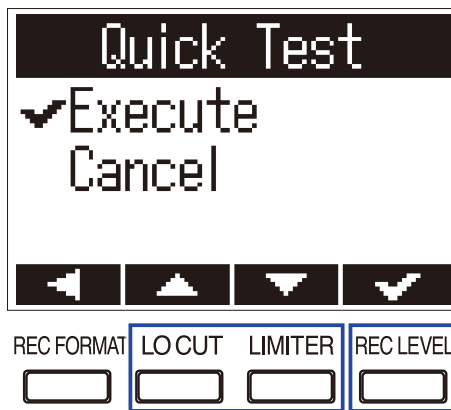

6. Check the result when the test completes.

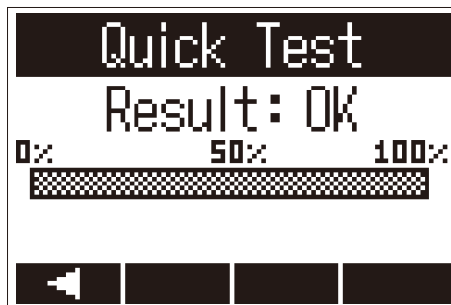

Conducting a full test

NOTE

Use the AC adapter to supply power when conducting a full test (→ ["Using an AC adapter"](#)).

1. While pressing , press  to open the MENU screen.

2. Use  and  to select "SD Card", and press .

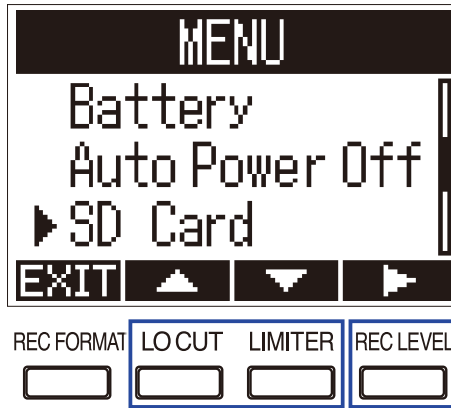

3. Use  or  to select "Test", and press .

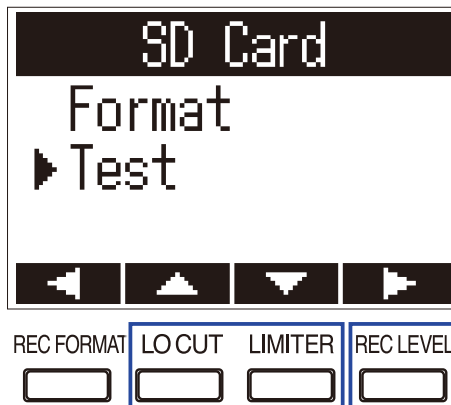

4. Use  or  to select "Full Test", and press .

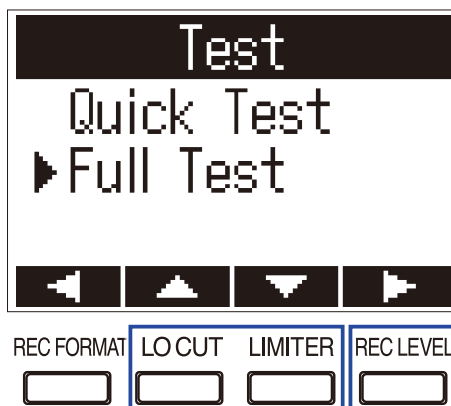

The estimated amount of time required for the full test will be shown.

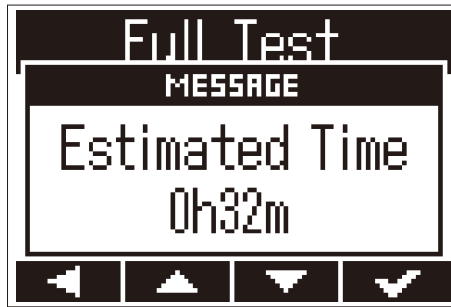

5. Use and to select "Execute", and press .

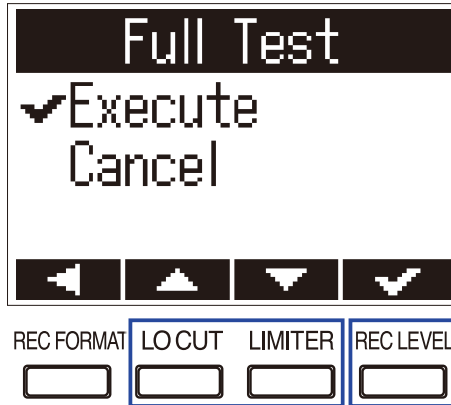

HINT



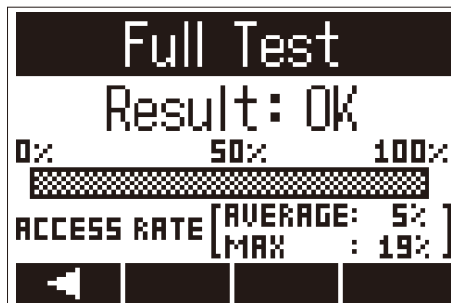

You can press  to pause and resume a test.

6. Check the result when the test completes.



Checking the firmware versions

You can check the current firmware versions.

1. While pressing , press  to open the MENU screen.
2. Use  and  to select "Version", and press .

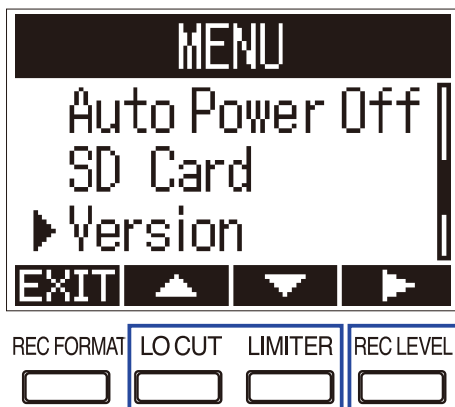

3. Check the firmware versions.

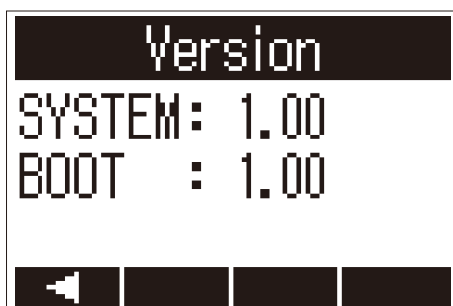

HINT

If a language file has been added, its version will also be shown.

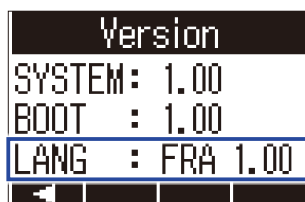

Restoring default setting values

You can restore all F1 settings to their factory defaults.

1. While pressing , press to open the MENU screen.
2. Use and to select "Factory Reset", and press .



3. Use and to select "Execute", and press .

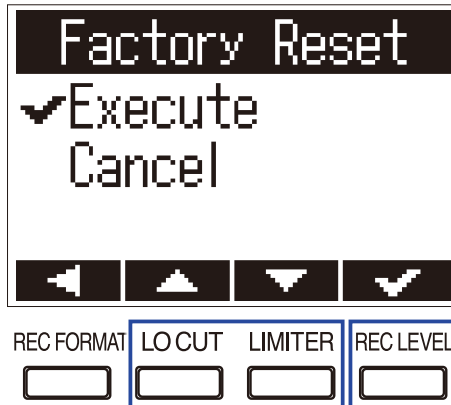

After the settings are restored, the power will automatically turn off.

NOTE

Restoring factory defaults will delete any added language file. (→ ["Adding languages"](#))

Updating the firmware

You can update the **F1** to the latest firmware version.

1. Install new batteries in the **F1** (→ ["Using batteries"](#)) or connect the dedicated AC adapter (→ ["Using an AC adapter"](#)).

NOTE

Executing a firmware update is not possible if the remaining battery power is low.

2. Copy the firmware update file to the root directory on a microSD card.

HINT

Files for the latest firmware updates can be downloaded from the ZOOM website (www.zoom.co.jp).

3. Insert the microSD card into the **F1** (→ ["Inserting microSD cards"](#))

4. While pressing , turn the power on.

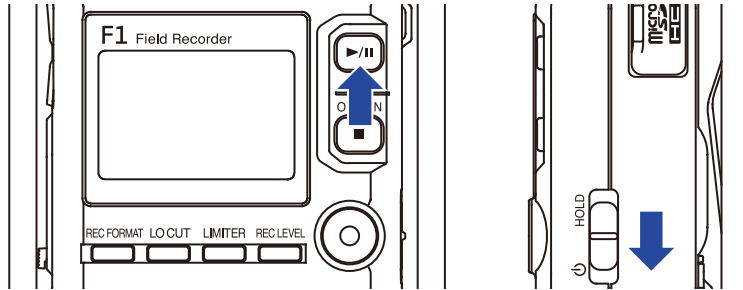

5. Use and to select "Update", and press .

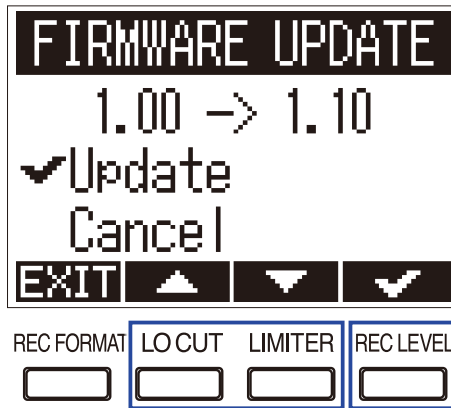

NOTE

During the firmware update, do not turn the power off or remove the microSD card. Doing so could cause the **F1** to become unstartable.

6. After the firmware update completes, turn the power off.



Troubleshooting

If your **F1** is not operating as intended, please check the following items first.

Recording/playback trouble

■ No sound is played/volume is low

- Confirm that the output volume of the **F1** is not set too low.
- Check the volume of the computer, iOS device or other equipment connected to the **F1**.

■ Recorded audio cannot be heard or is very quiet

- Confirm that the mic is pointed in the right direction.
- Check the input level settings (→ ["Adjusting input levels"](#)).
- Check the plug-in power setting (→ ["Setting plugin power"](#)).

■ Unable to record

- Confirm that the REC LED is lit (→ ["Names of parts"](#)).
- Check the remaining recordable time with the counter shown on the Home Screen (→ ["Home Screen \(in recording standby\)"](#)).
- Confirm that a microSD card is loaded properly in the card slot (→ ["Inserting microSD cards"](#)).
- If the HOLD function is on, buttons operations will be disabled. Disable the HOLD function (→ ["Preventing misoperation"](#)).

Other trouble

■ Computer does not recognize the **F1** when they are connected by a USB cable

- Confirm that the operating system of the connected computer is supported on the ZOOM website (www.zoom.co.jp).
- The USB function must be set on the **F1** to allow the computer to recognize the **F1** (→ ["Using as an audio interface"](#), ["Using as a card reader"](#)).

■ Battery operation time is short

Making the following changes could increase the battery operation time.

- Set the type of batteries used (→ ["Setting the type of battery used"](#)).
- Turn plug-in power off when not using it (→ ["Setting plugin power"](#)).
- Turn the display backlight off (→ ["Setting the display backlight"](#)).
- Reduce the sampling rate used to record files. (→ ["Selecting the recording format"](#)).
- Due to their characteristics, NiMH batteries (high-capacity ones recommended) or lithium batteries should enable longer use than alkaline batteries.

Specifications

Recording media	microSD/microSDHC cards (Class 4 or higher, up to 32 GB)		
Recording formats	WAV	44.1 kHz/16-bit, 48 kHz/16-bit, 48 kHz/24-bit, 96 kHz/24-bit Mono/stereo BWF formats supported	
	MP3	48 kbps, 128 kbps, 192 kbps, 256 kbps, 320 kbps Mono/stereo ID3v1 tags supported	
Display	1.25" monochrome LCD (96×64) with REC LED (red)		
Inputs	MIC IN	ZOOM mic capsule input	
	Mono shotgun mic (SGH-6)	Directionality	Super cardioid (3 directional mic units)
		Sensitivity	-39 dB/1 Pa at 1 kHz
		Input gain	-∞ – +50 dB
		Maximum sound pressure input	122 dB SPL
	MIC/LINE IN	Connector	3.5 mm stereo mini (with screw lock) Supports plug-in power (2.5 V)
		Input gain	-12 dB – +36 dB
		Input impedance	2 kΩ or more
	Lavalier mic	Plug	3.5 mm stereo mini (with screw lock)
		Directionality	Omnidirectional
		Sensitivity	-32 dB/1 Pa at 1kHz
		Maximum sound pressure input	115 dBspl
		Cable length	160 cm
	Outputs	PHONE OUT	Connector
		Maximum output level	11 mW + 11 mW (into 32Ω load)
USB	microUSB		
	Mass storage operation	USB 2.0 High Speed	
	Audio interface operation	USB class compliant 44.1kHz/16-bit, 48kHz/16-bit, 2-in/2-out Transfer method: asynchronous	
Power	2 AAA batteries (alkaline, NiMH or lithium) AC adapter (ZOOM AD-17): DC 5V/1A		
Estimated continuous recording time using batteries	With SGH-6 mono shotgun mic capsule connected (48 kHz/24-bit, mono) Alkaline batteries: about 6.5 hours NiMH batteries 750 mAh): about 6 hours Lithium batteries: about 11 hours		
	When using lavalier mic (48 kHz/24-bit, mono, plug-in power on) Alkaline batteries: about 10 hours NiMH batteries 750 mAh): about 9 hours Lithium batteries: about 16 hours		
	<ul style="list-style-type: none"> • The above values are approximate. • Continuous battery operation times were determined using in-house testing methods. They will vary greatly according to use conditions. 		
External dimensions	64.0 mm (W) × 79.8 mm (D) × 33.3 mm (H)		
Weight (main unit only)	120 g		



ZOOM CORPORATION

4-4-3 Kanda-surugadai, Chiyoda-ku, Tokyo 101-0062 Japan
www.zoom.co.jp